

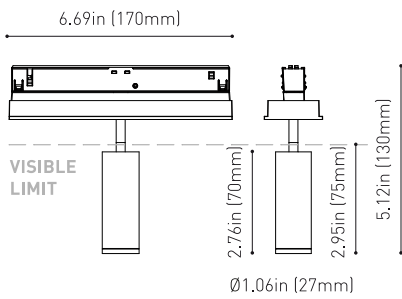

DIMENSIONS



ACCESORIES



BLACK FOSTER CUSTOM
ACCESSORIES

PRODUCT

Name	BLACK FOSTER CUSTOM MODULE FIT 27 UL MEDIUM DIM 0/10V 4000K G
Reference	U4540122G
Color	Gold
Category	Custom Systems

LIGHT SOURCE

Type	LED
Gross luminous flux	600 Lm
Color temperature	4000 K
Chromatic stability	MacAdam Step 2
Color Rendering Index	CRI > 90
Power	5.5 W
Efficacy	109 Lm/W
LED lifespan	L90B10 > 108.000h

LIGHTING FIXTURE | PHOTOMETRIC DATA

Lighting efficiency	82%
Delivered luminous flux	492 Lm
Light beam angle	31°

LIGHTING FIXTURE | ELECTRICAL DATA

Power values of the system	7,00 W
Dimming	0-10V

OTHER DATA

Environmental location	DAMP
Swivel angle	90°
Rotation angle	355°
Track type	Black Foster Custom Surface Track
Weight	0.35 lb 160 gr
Packaged weight	0.47 lb 217 gr
Packaging dimensions	8.27 x 4.41 x 2.13 in 210 x 112 x 54 mm
Materials	Aluminium / Polycarbonate



Fit 27 is a projector for the Black Foster custom system. Cylindrical geometry and essential forms, it stands out for its minimalistic looking and its functionality as it can be orientated in any direction. The black perimeter around its mouth highlights its anti-glare vocation.

POLAR DIAGRAM



CONICAL DIAGRAM



UGR

Glare Evaluation According to UGR											
ρ Ceiling	70	70	50	50	30	70	70	50	50	30	
ρ Walls	50	30	50	30	30	50	30	50	30	30	
ρ Floor	20	20	20	20	20	20	20	20	20	20	
Room Size X Y		Viewing direction at right angles to lamp axis					Viewing direction parallel to lamp axis				
2H	2H	12.6	13.3	12.8	13.4	13.6	12.7	13.4	13.0	13.6	13.8
	3H	13.2	13.8	13.5	14.0	14.3	13.2	13.8	13.4	14.0	14.2
	4H	13.5	14.0	13.8	14.3	14.6	13.5	14.1	13.8	14.3	14.6
	6H	13.9	14.4	14.2	14.7	15.0	13.9	14.5	14.2	14.7	15.0
	8H	14.2	14.7	14.5	15.0	15.3	14.2	14.7	14.6	15.0	15.3
4H	12H	14.6	15.0	14.9	15.3	15.7	14.6	15.1	15.0	15.4	15.7
	2H	12.8	13.4	13.1	13.6	13.9	12.9	13.5	13.2	13.7	14.0
	3H	13.5	14.0	13.9	14.3	14.6	13.5	14.0	13.8	14.3	14.6
	4H	14.0	14.4	14.3	14.7	15.1	14.0	14.4	14.4	14.7	15.1
	6H	14.6	14.9	15.0	15.3	15.7	14.6	15.0	15.0	15.3	15.7
8H	8H	15.0	15.3	15.4	15.7	16.1	15.1	15.4	15.5	15.8	16.2
	12H	15.6	15.8	16.0	16.2	16.7	15.7	15.9	16.1	16.3	16.7
	4H	14.1	14.4	14.5	14.8	15.2	14.1	14.5	14.6	14.8	15.2
	6H	15.0	15.2	15.4	15.6	16.1	15.0	15.2	15.5	15.7	16.1
12H	8H	15.6	15.8	16.0	16.2	16.7	15.7	15.8	16.1	16.3	16.8
	12H	16.4	16.5	16.9	17.0	17.5	16.5	16.6	16.9	17.1	17.6
	4H	14.2	14.4	14.6	14.8	15.3	14.2	14.5	14.6	14.9	15.3
6H	15.1	15.3	15.6	15.7	16.2	15.1	15.3	15.6	15.8	16.2	
8H	15.8	15.9	16.3	16.4	16.9	15.9	16.0	16.4	16.5	17.0	
Variation of the observer position for the luminaire distances S											
S = 1.0H	+3.9 / -3.4					+3.9 / -3.3					
S = 1.5H	+6.5 / -4.0					+6.5 / -4.1					
S = 2.0H	+8.4 / -4.9					+8.4 / -5.0					
Standard table	BK01					BK01					
Correction Summand	2.5					2.6					
Corrected Glare Indices referring to 640lm Total Luminous Flux											

Black Foster Custom System components

ARKOSLIGHT

Black Foster Custom System is a modular 48V lighting system designed to create tailored lighting setups by combining tracks, connectors, lighting modules, and accessories. Ideal for architectural and retail projects that demand flexibility, minimalist design, and high performance.

To configure the Black Foster Custom System, you'll need to combine the following components:

1. Tracks - Available in surfac, or suspended versions (using suspension accessories with the surface track), they form the structural and electrical base of the system.
2. Connectors & Power Supply - Join track sections and provide 48V power input.
3. Accessories - Including end caps, joining elements, mounting accessories, and alternative installation parts to secure and finish the system.



Track Options

Choose all the track components required for your project configuration.

BLACK FOSTER Custom Surface 3.28ft (1m) UL	U452-01-00- NT WT
BLACK FOSTER Custom Surface 6.56ft (2m) UL	U452-02-00- NT WT

BLACK FOSTER Custom Surface L-Joint UL	U452-04-00- NT WT
BLACK FOSTER Custom Surface T-Joint UL	U452-05-00- NT WT
BLACK FOSTER Custom Surface X-Joint UL	U452-06-00- NT WT

CUSTOM SURFACE PROFILE



L-JOINT



T-JOINT



X-JOINT



Complementary track accessories

Use end caps, joiners, and gap covers to connect, close, and cleanly finish your track setup.

BLACK FOSTER Custom Surface	
End UL	U452-00-03- N W

Cover thickness = 0.12in (3mm)



BLACK FOSTER Custom Surface	
End Feed UL	U452-00-04- N W

Cover thickness = 0.12in (3mm)



BLACK FOSTER Custom Surface	
Straight Joiner UL	U452-00-05

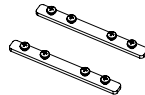

BLACK FOSTER Suspension Kit (2 Units) UL	
U450-00-09- NT WT	

Suggested Mounting accessories quantities

- 3.28ft (1000mm) - 2 Pcs.
- 6.56ft (2000mm) - 3 Pcs.

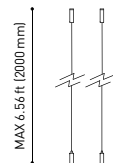

Suspension Feed Kit 48V UL	
U338-00-17- N W	DIM

*For remote power supply

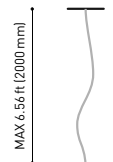

BLACK FOSTER Custom Cover Gap 250 UL	U452-00-01- N	9.48in / 250mm
BLACK FOSTER Custom Cover Gap 500 UL	U452-00-02- N	16.69in / 500mm

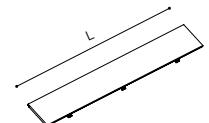

COLOUR | NT ■ RAL 9005 | WT □ RAL 9016 | N ■ RAL 9005 |

Electrical connections are not included. Please choose the required components from the Connectors section.



Connector options

Connectors are required to provide electrical continuity between tracks, ensuring an uninterrupted 48V flow.

Live-End Connector 48V UL

U338-00-01- | N |



Central Connector 48V UL

U338-00-02- | N |



L-Joint Connector 48V UL

U338-00-12- | N |



T-Joint Connector 48V UL

U450-00-07- | N |



X-Joint Connector 48V UL

U450-00-08- | N |



Power Supply Options

Select the appropriate power feed to deliver 48V to the system based on your track layout and installation type.

	P	V	D
Constant Voltage LED POWER SUPPLY	U100-00-78	96W	48V 8.16 x 2.97 x 1.30 in 207 x 75.4 x 33 mm

120 & 277V | 50/60 Hz

UL DROP
VOLTAGE TABLE

		CABLE LENGTH			
		16.40ft	32.80ft	65.62ft	98.43ft
		5m	10m	20m	30m
POWER	CABLE SECTION	TRACK LENGTH			
96 W	AWG16	164ft	164ft	131.32ft	82ft
		50m	50m	40m	25m

Connection diagrams:

Surface



Suspension



COLOUR | N ■ RAL 9005 | W □ RAL 9016 |