

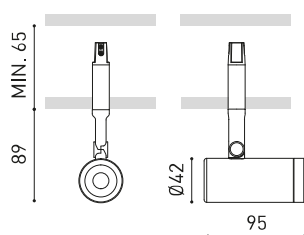

## DIMENSIONES

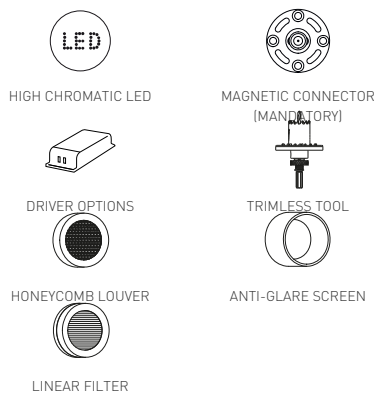

## ACCESORIOS



Nombre	MAGNETIC 24V COCO SPOT 2700K NT
Referencia	A4990010NT
Color	Negro Texturado
RAL	9005
Categoría	CEILING RECESSED

## FUENTE DE LUZ

Tipo	LED
Flujo Luminoso	1200 lm
Temperatura de color	2700 K
Estabilidad cromática	MacAdam Step 2
Índice de reproducción cromática	CRI > 90
Potencia	8,7 W
Corriente	500 mA
Eficacia	138 lm/W
Horas de Vida del LED	L80B10 > 66.000h

## LUMINARIA | DATOS FOTOMÉTRICOS

Eficiencia Lumínica	87%
Ángulo del haz de luz	20°

## LUMINARIA | DATOS ELÉCTRICOS

Driver	Incluido
Potencia del sistema	9,62 W
Tensión	24Vdc
Regulación	No Dim
Clase de seguridad eléctrica	II

## OTROS DATOS

Estanqueidad	IP20
Control inalámbrico	Consultar
Ángulo de basculación	90°
Ángulo de giro	360°
Peso	205 g
Peso con embalaje	286 g
Dimensiones embalaje	210 x 164 x 57 mm
Unidades por embalaje	1
Materiales	Aluminio / Acrilonitrilo Butadieno Estireno / Policarbonato

Una solución liviana y poderosa. Con una excepcional relación lm/V, Coco ofrece cuatro grados de apertura y distintos accesorios para favorecer el confort visual.

DIAGRAMA POLAR



DIAGRAMA CÓNICO



PARA PRESENTACIÓN COMERCIAL DE PRODUCTO

Vivid Model Colour Temperature	2700K	3000K	3500K	4000K	Light Pink
📖 Reading			•	•	
🥬 Fruits & Vegetables		•	•		
🍞 Bakery	•				
👤 Retail		•	•		
💄 Cosmetics			•	•	
🥩 Meat					•
🐟 Fish				•	
🐠 Seafood				•	•

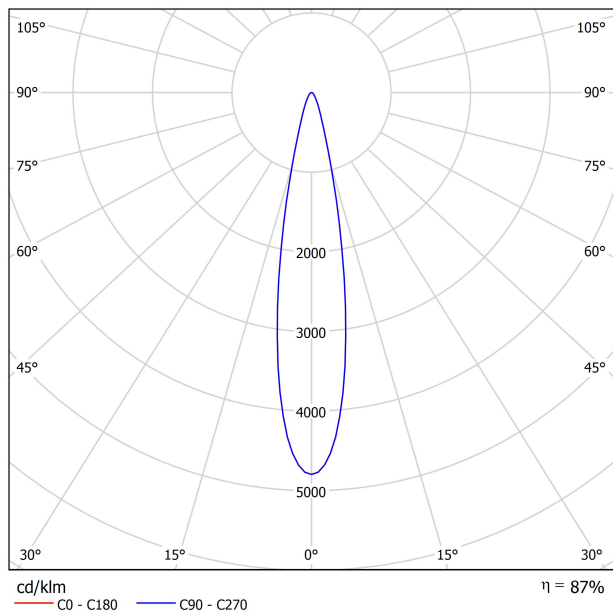
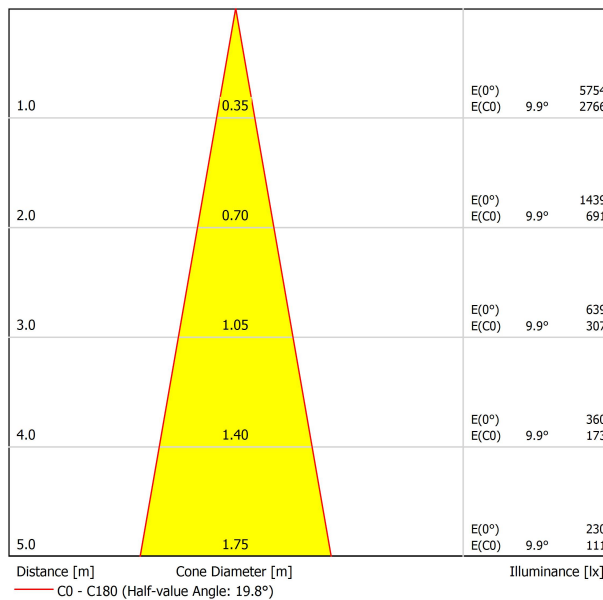

Arkosligh ofrece en algunos de sus productos la posibilidad de dotarlos de un LED especial para iluminación orientada a la promoción visual de bienes y productos con finalidad comercial.

Se trata de un LED de alta cromaticidad que persigue destacar los tonos que favorecen la percepción psicológica positiva del objeto iluminado.

Esta fuente de luz LED especial ofrece una paleta de colores más atractiva e intensa, por encima de lo que lo hace un LED convencional. Esto se consigue gracias a la configuración del LED bajo un "parámetro especial de saturación" que consigue que los colores y la textura de los objetos se muestren más atractivos dentro del espectro de luz visible. Para ello se selecciona, en cada caso, el diodo pertinente y su fósforo de recubrimiento específico.

# MAGNETIC 24V CONNECTOR

ARKOSLIGHT®

MANDATORY FOR INSTALLATION

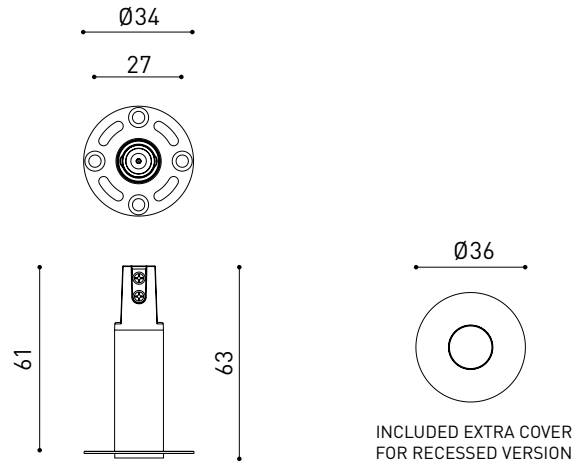

PRODUCT	
Model	Magnetic connector accessory
Reference	A435-01- 00   W <input type="checkbox"/>   N <input checked="" type="checkbox"/>
Category	Accessories



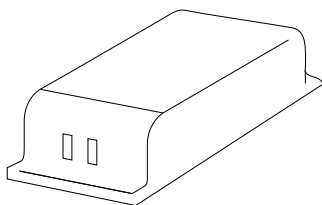

			P	V	D (A x B x C)
24V Power Supply	ON/OFF	0434-01-37	60W	24V	180 x 52 x 30mm
		0433-10-22	100W	24V	295 x 43 x 30mm

220 V~  
240 V~

TO BE INSTALLED ON REMOTE

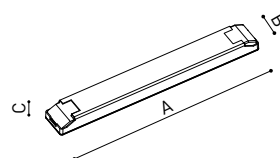

			P	V	D (A x B x C)
24V Dimmer		0433-01-32	DALI/PUSH	24V	181 x 42 x 20mm
		0433-01-33	CASAMBI	24V	172 x 42 x 20mm
		0434-01-64	WIFI	24V	105 x 44 x 23mm

24V

TO BE INSTALLED ON REMOTE

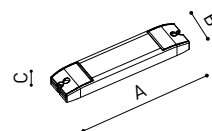

DROP VOLTAGE TABLE

POWER (W)	CABLE SECTION (mm <sup>2</sup> )	CABLE LENGHT (m)
60	0,75	30
	1,5	30
100	0,75	20
	1,5	30

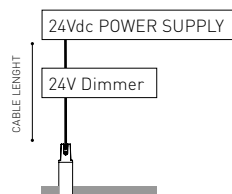



INSTALLATION GUIDE

[https://youtu.be/sa\\_xAgj4ji4](https://youtu.be/sa_xAgj4ji4)

PRODUCT	
Model	Trimless Tool <b>D16 X D34 MM</b>
Reference	A478-00-00
Category	Accessories

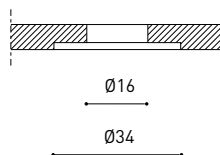
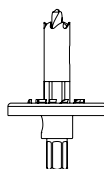



	PRODUCT
Model	Anti-glare Honeycomb Louver
Reference	<b>A498-90-00</b>   WT   NT
Category	Accessories
	NOT SOLD SEPARATELY



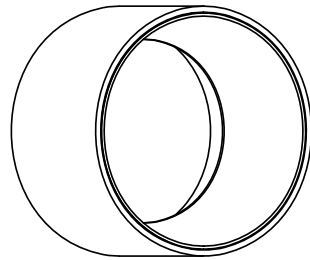

	PRODUCT
Model	Anti-glare Screen
Reference	<b>A498-90-01</b>   WT   NT
Category	Accessories
	NOT SOLD SEPARATELY





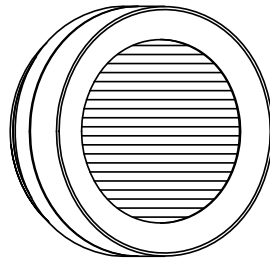

	PRODUCT
Model	Linear Filter
Reference	<b>A498-90-02   WT   NT  </b>
Category	Accessories
	NOT SOLD SEPARATELY <span style="float: right;">SUITABLE FOR BEAM <math>\leq</math> 34°</span>



Fuente de luz (LED) reemplazable por un profesional autorizado

Replaceable (LED only) light source by an authorized professional.

Source lumineuse (LED) remplaçable par un professionnel agréé

Sorgente luminosa (LED) sostituibile da parte di un professionista autorizzato

Austauschbare (LED) Lichtquelle durch einen autorisierten Fachmann



Equipo de control reemplazable por un profesional autorizado

Replaceable control gear by an authorized professional

Dispositif de commande remplaçable par un professionnel agréé

Alimentatore sostituibile da parte di un professionista autorizzato

Auswechselbares Betriebsgerät durch autorisierten Fachmann

INSTRUCCIONES PARA EL FINAL DE VIDA Y LA ELIMINACIÓN LOS COMPONENTES  
 INSTRUCTIONS ON END-OF-LIFE AND COMPONENT DISPOSAL  
 INSTRUCTIONS POUR LA GESTION DES COMPOSANTS EN FIN DE VIE ET LEUR MISE AU REBUT  
 ISTRUZIONI PER IL FINE VITA E LO SMALTIMENTO DEI COMPONENTI  
 ANWEISUNGEN ZUR ENTSORGUNG DER LEUCHTENKOMPONENTEN



Interrumpir la alimentación del aparato  
 Cut the power supply to the luminaire  
 Couper l'alimentation du luminaire  
 Interrompere l'alimentazione dell'apparecchio  
 Stromversorgung der Leuchte unterbrechen



Quitar la(s) fuente(s) de luz para el desecho  
 Remove light source(s) for disposal  
 Retirer la (les) source(s) lumineuse(s) pour l'élimination  
 Rimuovere la/le sorgente/e di luce per lo smaltimento  
 Lichtquelle(n) zur Entsorgung entfernen



Quitar la batería para el desecho  
 Remove the battery for decommissioning  
 Retirer la batterie pour sa mise au rebut  
 Rimuovere la batteria per la dismissione  
 Die Batterie ordnungsgemäß entsorgen



Quitar el equipo de control para el desecho  
 Remove control gear for disposal  
 Retirer le dispositif de commande pour l'élimination  
 Rimuovere l'alimentatore per lo smaltimento  
 Betriebsgerät zur Entsorgung ausbauen



Enviar los materiales a un centro de recogida RAEE  
 Send the materials to a WEEE collection centre  
 Envoyer les matériaux dans une déchetterie DEEE  
 Inviare i materiali ad un centro di raccolta RAEE  
 Die Materialien in einem WEEE-Zentrum entsorgen

