

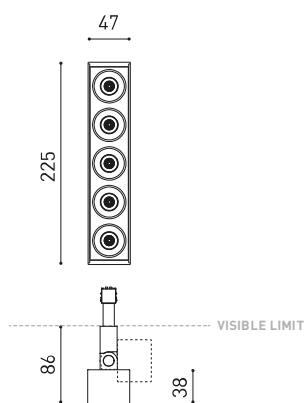

GRÖÖE



ZUBEHÖR



TRACK 48V OPTIONS

Name	BLACK FOSTER 48V TILT 5 FLOOD DIM DALI 3000K NT
Artikelnummer	A4814021NT
Farbe	Schwarz strukturiert
RAL	9005
Kategorie	TRACKLIGHTS

Typ	LED
Bruttolichtstrom	1050 lm
Farbtemperatur	3000 K
Farbstabilität	MacAdam Step 3
Farbwiedergabeindex	CRI > 90
Leistung	10,5 W
Stromstärke	700 mA
Lichtausbeute	100 lm/W
Nutzlebensdauer der LED in Betriebsstunden	L90B10 > 102.000h

Leuchtenwirkungsgrad (LOR)	92%
Abstrahlwinkel	38°

Driver	Inklusiv
Leistungswerte des Systems	12,14 W
Spannung	48Vdc
Helligkeitssteuerung	DALI
Schutzklasse	III

Dichtigkeit	IP20
Wireless control	Bitte anfragen
Schwenkwinkel	90°
Drehwinkel	360°
Schiementyp	Track 48V
Gewicht	450 g
Gewicht inkl. Verpackung	550 g
Abmessungen der Verpackung	268 x 172 x 62 mm
Stück pro Verpackung	1
Materialien	Aluminium / Acrylnitril-Butadien-Styrol / Polycarbonat

PRODUKT

LICHTQUELLE

LEUCHE | PHOTOMETRISCHE DATEN

LEUCHE | ELEKTRISCHE DATEN

ANDERE DATEN

Die neue Beleuchtungsoption Black Foster 48v Tilt hat eine neue Kippfunktion an der 48V-Schiene von 90° bis 360°. Dank dieser neuen Funktion von Black Foster wird das Licht frei, präzise und in Winkeln projiziert, um spannende Szenen zu schaffen.

POLAR-KOORDINATEN DIAGRAMM



KEGELDIAGRAMM

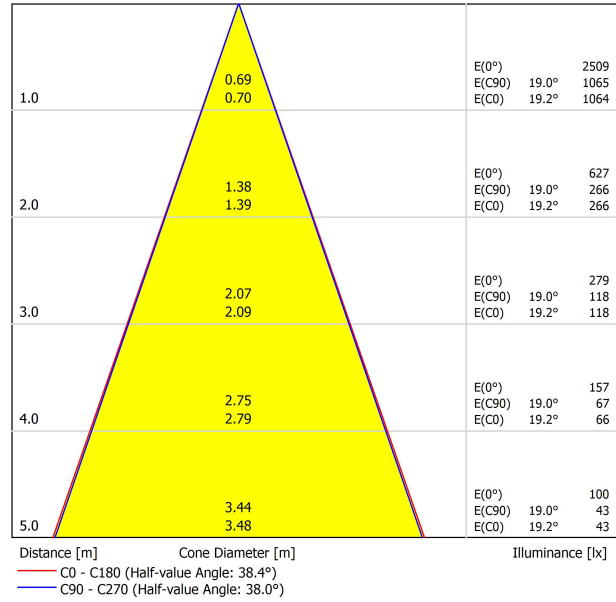

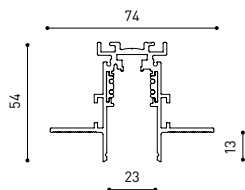
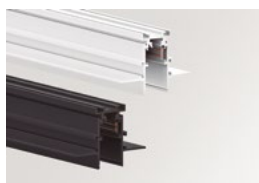

TRACK 48V TRIMLESS

TRACK 48V TRIMLESS 1m	A338-01-00- N WT
TRACK 48V TRIMLESS 2m	A338-02-00- N WT
TRACK 48V TRIMLESS 3m	A338-03-00- N WT
TRACK 48V TRIMLESS Corner 90° One Plane	A338-06-00- N WT
TRACK 48V TRIMLESS Corner 90° Two Planes	A338-07-00- N WT

PLASTERBOARD CEILING, MANDATORY THICKNESS 12,5mm.
RECOMMENDED FOR INSTALLATIONS WHERE THE PROFILE CAN BE
INSTALLED BEFORE THE FALSE PLASTERBOARD CEILING.



TRIMLESS INSTALLATION GUIDE

<https://youtu.be/tgGsQdaYe-w>

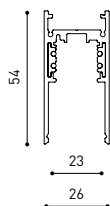

TRACK 48V SURFACE

TRACK 48V SURFACE 1m	A338-11-00- NT WT
TRACK 48V SURFACE 2m	A338-12-00- NT WT
TRACK 48V SURFACE 3m	A338-13-00- NT WT
TRACK 48V SURFACE Corner 90° One Plane	A338-14-00- NT WT



TRACK 48V TRIMLESS Corner 90° One Plane

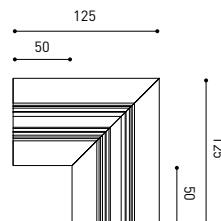

*Electrical connection not included

TRACK 48V TRIMLESS Corner 90° Two Planes

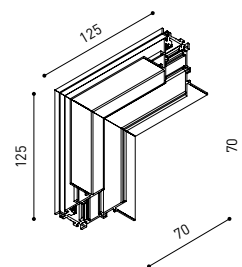

*Electrical connection not included

TRACK 48V SURFACE Corner 90° One Plane

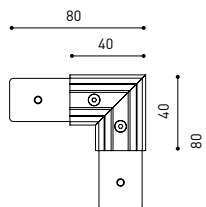

Electrical connection not included
Straight joiner included

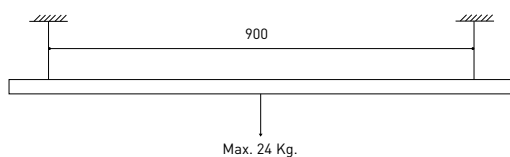

DROP VOLTAGE TABLE

POWER [W]	CABLE SECTION [mm ²]	CABLE LENGTH (m)			
		5	10	20	30
100	0,75	50	50	X	X
	1,5	50	50	40	25
150	0,75	40	15	X	X
	1,5	50	40	20	X

	P	V	D	
CONSTANT VOLTAGE LED POWER SUPPLY	0434-01-61* N	100W	48V	298 x 16 x 19 mm
	0434-01-62	150W	48V	350 x 30 x 18 mm

220 V₋
240

*To be installed inside the track.

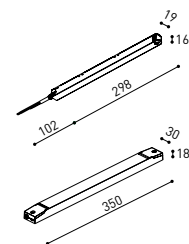

COLOUR | N ■ RAL 9005 | NT ■ RAL 9005 | WT □ RAL 9016 |

ALL 48V TRACK



Live-End Connector 48V
A338-00-01- | W | N |



Central Connector 48V
A338-00-02- | W | N |



L-JOINT Connector 48V
A338-00-12- | W | N |



Wireless Control 48V
0434-01-31- | W | N | Casambi/AAG Stucchi App



Corner 90° Connector One Plane 48V
A338-00-24- | W | N |



Cover Gap 1m 48V
A338-00-30- | N | W |

*Not suitable for trimless version

TRIMLESS 48V



Trimless T-Bracket 48V
A338-00-03



Trimless Clamp for M6 ROD 48V
A338-00-09
*See accessories quantities



Trimless Long T-Bracket 48V
A338-00-04



Trimless Track Clamp 48V
A338-00-10
*See accessories quantities



Trimless Straight Joiner 48V (2 Units)
A338-00-05- | WT | N |



Trimless Suspension Kit 48V
A338-00-08
*See accessories quantities



Trimless Plaster Installation Guard 1m 48V
A338-00-21

*** SUGGESTED MOUNTING ACCESSORIES QUANTITIES**
1000mm - 2 Pcs.
2000mm - 3 Pcs.
3000mm - 4 Pcs.

COLOUR | N ■ RAL 9005 | W □ RAL 9016 | NT ■ RAL 9005 | WT □ RAL 9016 |

TRIMLESS, SURFACE & SUSPENSION 48V



End 48V

A338-00-06- | WT | NT |



End feed 48V

A338-00-07- | WT | NT |

SURFACE, SUSPENSION 48V



Surface Straight Joiner 48V

A338-00-11

SURFACE 48V

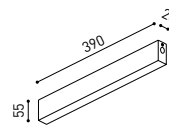

TRACK 48V Power Supply Case

A338-00-29- | NT | WT | 150 W



*To be installed aside 48V Surface Tracks

SUSPENSION 48V

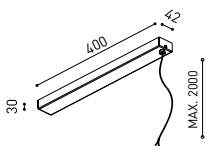

Wired Power Supply Case 48V

A338-00-25- | NT | WT | 150 W NO DIM

A338-00-26- | NT | WT | 150 W DIM

220 V -
240

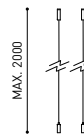

Suspension Kit 48V (2 units)

A338-00-15- | WT | NT |

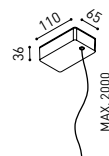

Suspension Feed Kit 48V

A338-00-16- | W | N | NO DIM

A338-00-17- | W | N | DIM

For remote power supply

A338-00-27- | W | N | NO DIM

A338-00-28- | W | N | DIM

For power supply inside the track

WIRE TRIMLESS ACCESSORIES

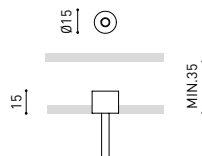

FEED

MAINS TRIMLESS*

A023-00-01- | W | N | NO DIM

MAINS THICK TRIMLESS*

A023-00-02- | W | N | DIM

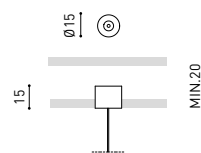

FASTENING

STEEL CABLE TRIMLESS*

A023-00-05- | W | N |



MAINS TRIMLESS

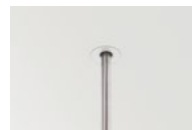

MAINS THICK TRIMLESS

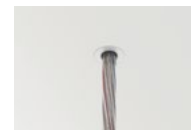

STEEL CABLE TRIMLESS

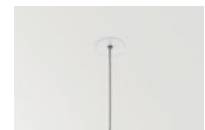

* AS MANY PIECES AS NEEDED ACCORDING TO YOUR PRODUCT

COLOUR | N ■ RAL 9005 | W □ RAL 9016 | NT ■ RAL 9005 | WT □ RAL 9016 |



Fuente de luz (LED) reemplazable por un profesional autorizado

Replaceable (LED only) light source by an authorized professional.

Source lumineuse (LED) remplaçable par un professionnel agréé

Sorgente luminosa (LED) sostituibile da parte di un professionista autorizzato

Austauschbare (LED) Lichtquelle durch einen autorisierten Fachmann



Equipo de control reemplazable por un profesional autorizado

Replaceable control gear by an authorized professional

Dispositif de commande remplaçable par un professionnel agréé

Alimentatore sostituibile da parte di un professionista autorizzato

Auswechselbares Betriebsgerät durch autorisierten Fachmann

INSTRUCCIONES PARA EL FINAL DE VIDA Y LA ELIMINACIÓN LOS COMPONENTES
 INSTRUCTIONS ON END-OF-LIFE AND COMPONENT DISPOSAL
 INSTRUCTIONS POUR LA GESTION DES COMPOSANTS EN FIN DE VIE ET LEUR MISE AU REBUT
 ISTRUZIONI PER IL FINE VITA E LO SMALTIMENTO DEI COMPONENTI
 ANWEISUNGEN ZUR ENTSORGUNG DER LEUCHTENKOMPONENTEN



Interrumpir la alimentación del aparato
 Cut the power supply to the luminaire
 Couper l'alimentation du luminaire
 Interrompere l'alimentazione dell'apparecchio
 Stromversorgung der Leuchte unterbrechen



Quitar la(s) fuente(s) de luz para el desecho
 Remove light source(s) for disposal
 Retirer la (les) source(s) lumineuse(s) pour l'élimination
 Rimuovere la/le sorgente/e di luce per lo smaltimento
 Lichtquelle(n) zur Entsorgung entfernen



Quitar la batería para el desecho
 Remove the battery for decommissioning
 Retirer la batterie pour sa mise au rebut
 Rimuovere la batteria per la dismissione
 Die Batterie ordnungsgemäß entsorgen



Quitar el equipo de control para el desecho
 Remove control gear for disposal
 Retirer le dispositif de commande pour l'élimination
 Rimuovere l'alimentatore per lo smaltimento
 Betriebsgerät zur Entsorgung ausbauen



Enviar los materiales a un centro de recogida RAEE
 Send the materials to a WEEE collection centre
 Envoyer les matériaux dans une déchetterie DEEE
 Inviare i materiali ad un centro di raccolta RAEE
 Die Materialien in einem WEEE-Zentrum entsorgen

