

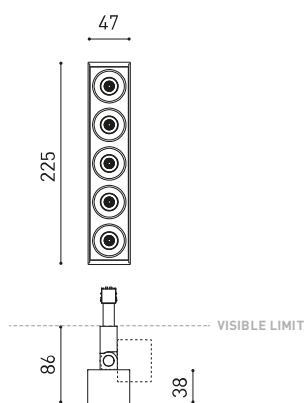

GRÖÖE



ZUBEHÖR



TRACK 48V OPTIONS

| | |
|---------------|--|
| Name | BLACK FOSTER 48V TILT 5 FLOOD 4000K NTMG |
| Artikelnummer | A4814012NTMG |
| Farbe | Schwarz strukturiert-Metallisiertes Gold |
| RAL | Metalllic-Finish |
| Kategorie | TRACKLIGHTS |

| | |
|--|-------------------|
| Typ | LED |
| Bruttolichtstrom | 1250 lm |
| Farbtemperatur | 4000 K |
| Farbstabilität | MacAdam Step 3 |
| Farbwiedergabeindex | CRI > 90 |
| Leistung | 10,5 W |
| Stromstärke | 700 mA |
| Lichtausbeute | 119 lm/W |
| Nutzlebensdauer der LED in Betriebsstunden | L90B10 > 102.000h |

| | |
|----------------------------|-----|
| Leuchtenwirkungsgrad (LOR) | 92% |
| Abstrahlwinkel | 38° |

| | |
|----------------------------|----------|
| Driver | Inklusiv |
| Leistungswerte des Systems | 11,72 W |
| Spannung | 48Vdc |
| Helligkeitssteuerung | No Dim |
| Schutzklasse | II |

| | |
|----------------------------|--|
| Dichtigkeit | IP20 |
| Wireless control | Bitte anfragen |
| Schwenkwinkel | 90° |
| Drehwinkel | 360° |
| Schiementyp | Track 48V |
| Gewicht | 450 g |
| Gewicht inkl. Verpackung | 550 g |
| Abmessungen der Verpackung | 268 x 172 x 62 mm |
| Stück pro Verpackung | 1 |
| Materialien | Aluminium / Acrylnitril-Butadien-Styrol / Polycarbonat |

PRODUKT

LICHTQUELLE

LEUCHE | PHOTOMETRISCHE DATEN

LEUCHE | ELEKTRISCHE DATEN

ANDERE DATEN

Die neue Beleuchtungsoption Black Foster 48v Tilt hat eine neue Kippfunktion an der 48V-Schiene von 90° bis 360°. Dank dieser neuen Funktion von Black Foster wird das Licht frei, präzise und in Winkeln projiziert, um spannende Szenen zu schaffen.

POLAR-KOORDINATEN DIAGRAMM



KEGELDIAGRAMM

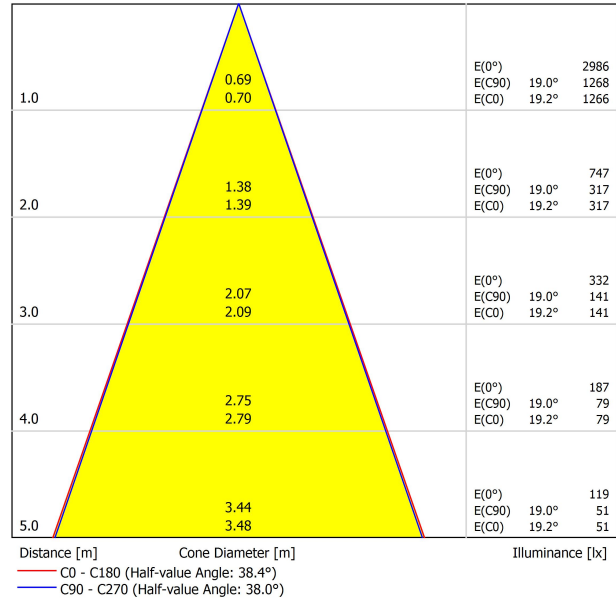

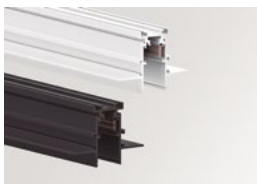

TRACK 48V TRIMLESS

| | |
|--|----------------------|
| TRACK 48V TRIMLESS 1m | A338-01-00- N WT |
| TRACK 48V TRIMLESS 2m | A338-02-00- N WT |
| TRACK 48V TRIMLESS 3m | A338-03-00- N WT |
| TRACK 48V TRIMLESS Corner 90° One Plane | A338-06-00- N WT |
| TRACK 48V TRIMLESS Corner 90° Two Planes | A338-07-00- N WT |

PLASTERBOARD CEILING, MANDATORY THICKNESS 12,5mm.
RECOMMENDED FOR INSTALLATIONS WHERE THE PROFILE CAN BE
INSTALLED BEFORE THE FALSE PLASTERBOARD CEILING.



TRIMLESS INSTALLATION GUIDE
<https://youtu.be/tgGsQdaYe-w>



TRACK 48V SURFACE

| | |
|--|-----------------------|
| TRACK 48V SURFACE 1m | A338-11-00- NT WT |
| TRACK 48V SURFACE 2m | A338-12-00- NT WT |
| TRACK 48V SURFACE 3m | A338-13-00- NT WT |
| TRACK 48V SURFACE Corner 90° One Plane | A338-14-00- NT WT |



TRACK 48V TRIMLESS Corner 90° One Plane



*Electrical connection not included

TRACK 48V TRIMLESS Corner 90° Two Planes

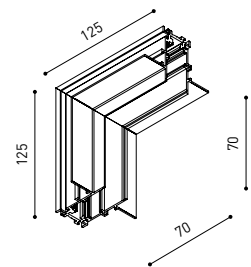

*Electrical connection not included

TRACK 48V SURFACE Corner 90° One Plane

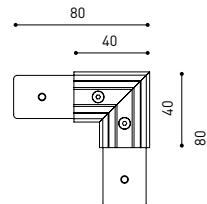

Electrical connection not included
Straight joiner included

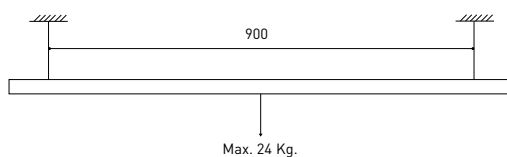

DROP VOLTAGE TABLE

| POWER [W] | CABLE SECTION [mm ²] | CABLE LENGTH (m) | | | |
|-----------|----------------------------------|------------------|----|----|----|
| | | 5 | 10 | 20 | 30 |
| 100 | 0,75 | 50 | 50 | X | X |
| | 1,5 | 50 | 50 | 40 | 25 |
| 150 | 0,75 | 40 | 15 | X | X |
| | 1,5 | 50 | 40 | 20 | X |

| | P | V | D | |
|-----------------------------------|-----------------|------|-----|------------------|
| CONSTANT VOLTAGE LED POWER SUPPLY | 0434-01-61* N | 100W | 48V | 298 x 16 x 19 mm |
| | 0434-01-62 | 150W | 48V | 350 x 30 x 18 mm |

220 V₋
240

*To be installed inside the track.

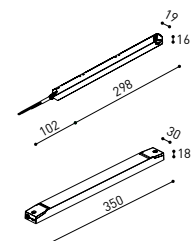

COLOUR | N ■ RAL 9005 | NT ■ RAL 9005 | WT □ RAL 9016 |

ALL 48V TRACK



Live-End Connector 48V
A338-00-01- | W | N |



Central Connector 48V
A338-00-02- | W | N |



L-JOINT Connector 48V
A338-00-12- | W | N |



Wireless Control 48V
0434-01-31- | W | N | Casambi/AAG Stucchi App



Corner 90° Connector One Plane 48V
A338-00-24- | W | N |

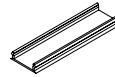

Cover Gap 1m 48V
A338-00-30- | N | W |

*Not suitable for trimless version

TRIMLESS 48V



Trimless T-Bracket 48V
A338-00-03



Trimless Clamp for M6 ROD 48V
A338-00-09
*See accessories quantities

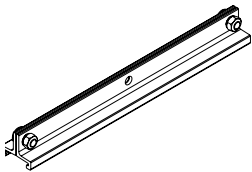

Trimless Long T-Bracket 48V
A338-00-04



Trimless Track Clamp 48V
A338-00-10
*See accessories quantities

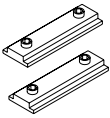

Trimless Straight Joiner 48V (2 Units)
A338-00-05- | WT | N |



Trimless Suspension Kit 48V
A338-00-08
*See accessories quantities

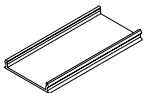

Trimless Plaster Installation Guard 1m 48V
A338-00-21

*** SUGGESTED MOUNTING ACCESSORIES QUANTITIES**
1000mm - 2 Pcs.
2000mm - 3 Pcs.
3000mm - 4 Pcs.

COLOUR | N ■ RAL 9005 | W □ RAL 9016 | NT ■ RAL 9005 | WT □ RAL 9016 |

TRIMLESS, SURFACE & SUSPENSION 48V



End 48V

A338-00-06- | WT | NT |



End feed 48V

A338-00-07- | WT | NT |

SURFACE, SUSPENSION 48V

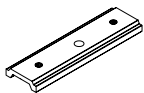

Surface Straight Joiner 48V

A338-00-11

SURFACE 48V

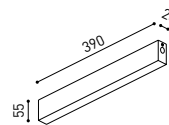

TRACK 48V Power Supply Case

A338-00-29- | NT | WT | 150 W

220 V - 240 V - INCL

*To be installed aside 48V Surface Tracks

SUSPENSION 48V

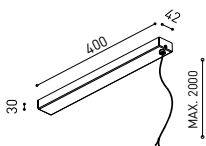

Wired Power Supply Case 48V

A338-00-25- | NT | WT | 150 W NO DIM

A338-00-26- | NT | WT | 150 W DIM

220 V - 240 V - INCL

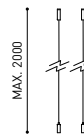

Suspension Kit 48V (2 units)

A338-00-15- | WT | NT |

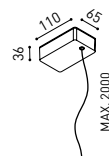

Suspension Feed Kit 48V

A338-00-16- | W | N | NO DIM

A338-00-17- | W | N | DIM

For remote power supply

A338-00-27- | W | N | NO DIM

A338-00-28- | W | N | DIM

For power supply inside the track

WIRE TRIMLESS ACCESSORIES

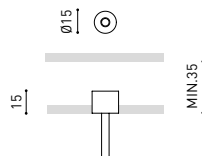

FEED

MAINS TRIMLESS*

A023-00-01- | W | N | NO DIM

MAINS THICK TRIMLESS*

A023-00-02- | W | N | DIM

REMOTE INCL Ø20

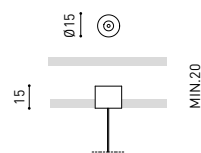

FASTENING

STEEL CABLE TRIMLESS*

A023-00-05- | W | N |

INCL Ø20

MAINS TRIMLESS

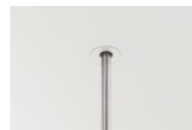

MAINS THICK TRIMLESS

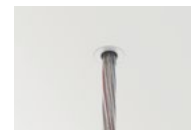

STEEL CABLE TRIMLESS

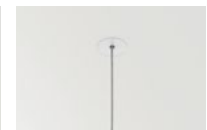

* AS MANY PIECES AS NEEDED ACCORDING TO YOUR PRODUCT

COLOUR | N ■ RAL 9005 | W □ RAL 9016 | NT ■ RAL 9005 | WT □ RAL 9016 |



Fuente de luz (LED) reemplazable por un profesional autorizado

Replaceable (LED only) light source by an authorized professional.

Source lumineuse (LED) remplaçable par un professionnel agréé

Sorgente luminosa (LED) sostituibile da parte di un professionista autorizzato

Austauschbare (LED) Lichtquelle durch einen autorisierten Fachmann



Equipo de control reemplazable por un profesional autorizado

Replaceable control gear by an authorized professional

Dispositif de commande remplaçable par un professionnel agréé

Alimentatore sostituibile da parte di un professionista autorizzato

Auswechselbares Betriebsgerät durch autorisierten Fachmann

INSTRUCCIONES PARA EL FINAL DE VIDA Y LA ELIMINACIÓN LOS COMPONENTES
 INSTRUCTIONS ON END-OF-LIFE AND COMPONENT DISPOSAL
 INSTRUCTIONS POUR LA GESTION DES COMPOSANTS EN FIN DE VIE ET LEUR MISE AU REBUT
 ISTRUZIONI PER IL FINE VITA E LO SMALTIMENTO DEI COMPONENTI
 ANWEISUNGEN ZUR ENTSORGUNG DER LEUCHTENKOMPONENTEN



Interrumpir la alimentación del aparato
 Cut the power supply to the luminaire
 Couper l'alimentation du luminaire
 Interrompere l'alimentazione dell'apparecchio
 Stromversorgung der Leuchte unterbrechen



Quitar la(s) fuente(s) de luz para el desecho
 Remove light source(s) for disposal
 Retirer la (les) source(s) lumineuse(s) pour l'élimination
 Rimuovere la/le sorgente/e di luce per lo smaltimento
 Lichtquelle(n) zur Entsorgung entfernen



Quitar la batería para el desecho
 Remove the battery for decommissioning
 Retirer la batterie pour sa mise au rebut
 Rimuovere la batteria per la dismissione
 Die Batterie ordnungsgemäß entsorgen



Quitar el equipo de control para el desecho
 Remove control gear for disposal
 Retirer le dispositif de commande pour l'élimination
 Rimuovere l'alimentatore per lo smaltimento
 Betriebsgerät zur Entsorgung ausbauen



Enviar los materiales a un centro de recogida RAEE
 Send the materials to a WEEE collection centre
 Envoyer les matériaux dans une déchetterie DEEE
 Inviare i materiali ad un centro di raccolta RAEE
 Die Materialien in einem WEEE-Zentrum entsorgen

