

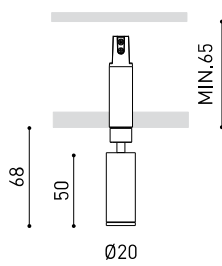

DIMENSIONS



ACCESSOIRES



MAGNETIC CONNECTOR
(MANDATORY)



TRIMLESS TOOL



DRIVER OPTIONS

TROPHÉES



PRODUIT

| | |
|-----------|----------------------------------|
| Nom | MAGNETIC 24V FIT 20 54° 2700K NT |
| Référence | A4310130NT |
| Couleur | Noir Texturé |
| RAL | 9005 |
| Catégorie | CEILING RECESSED |

SOURCE DE LUMIÈRE

| | |
|------------------------------------|------------------|
| Type | LED |
| Flux lumineux brut | 127 lm |
| Température de couleur | 2700 K |
| Stabilité chromatique | MacAdam Step 3 |
| Indice de reproduction chromatique | CRI > 90 |
| Puissance | 2,1 W |
| Courant | 700 mA |
| Efficacité | 60 lm/W |
| Durée de vie de la LED | L80B10 > 50.000h |

LUMINAIRE | DONNÉS PHOTOMÉTRIQUES

| | |
|----------------------------|-----|
| Efficacité lumineuse | 81% |
| Angle du faisceau lumineux | 54° |

LUMINAIRE | DONNÉS ÉLECTRIQUES

| | |
|---------------------------------|---------|
| Driver | Inclus |
| Valeurs de puissance du système | 2,92 W |
| Tension | 24Vdc |
| Variation d'intensité | Non Dim |
| Classe d'isolation électrique | II |

D'AUTRES DONNÉES

| | |
|---------------------------|---------------------------|
| Étanchéité | IP20 |
| Contrôle sans fil | Veillez consulter |
| Angle de basculement | 90° |
| Angle de rotation | 360° |
| Poids | 45 g |
| Poids avec emballage | 70 g |
| Dimensions de l'emballage | 112 x 90 x 26 mm |
| Unités par emballage | 1 |
| Matériaux | Aluminium / Polycarbonate |



Fit Magnetic est un projecteur pour applications encastrées isolées disponible en deux tailles (Ø20 et Ø27). De géométrie cylindrique et de formes essentielles, il se distingue par son minimalisme esthétique et sa fonctionnalité, car il peut être orienté dans toutes les directions. Le périmètre de sa bouche en noir et son accessoire de type panneau à lamelles d'abeille accentuent sa vocation anti-éblouissante.

DIAGRAMME POLAIRE



DIAGRAMME CONIQUE



MAGNETIC 24V CONNECTOR

ARKOSLIGHT®

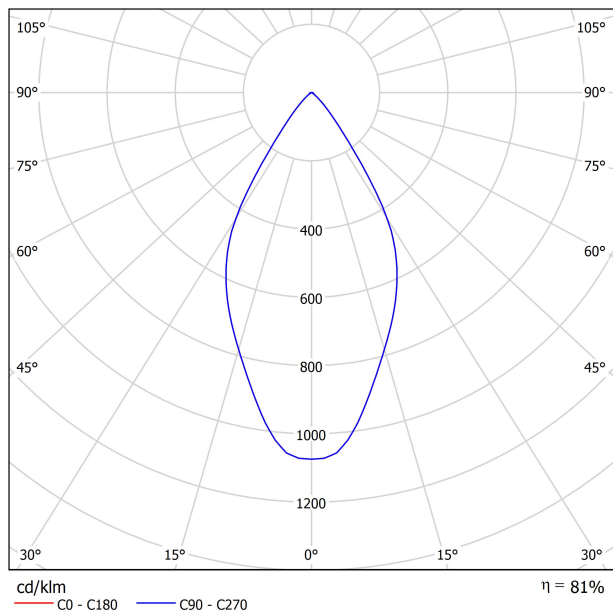
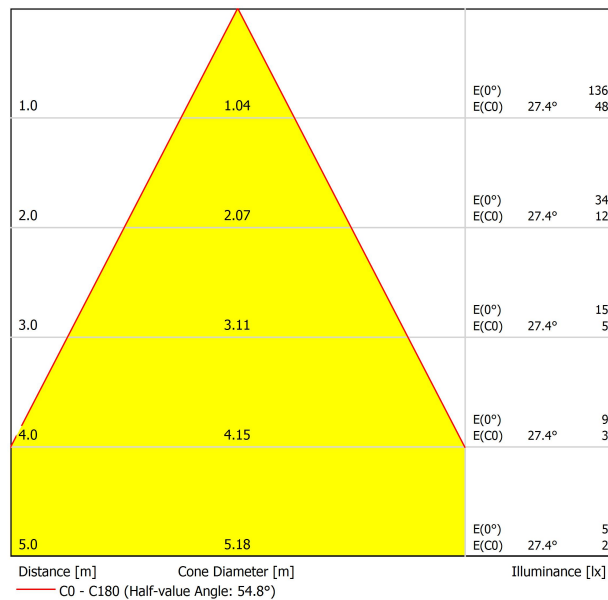
MANDATORY FOR INSTALLATION

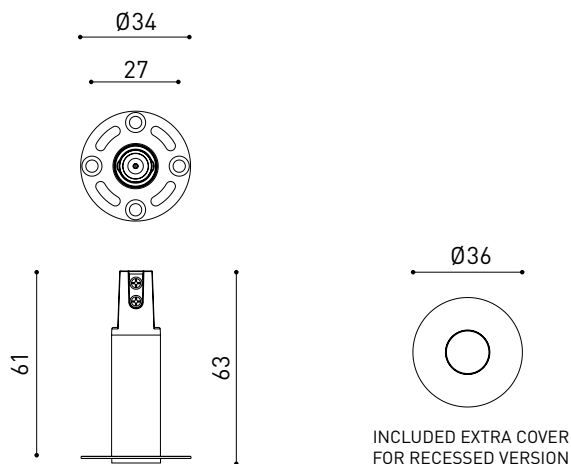

| PRODUCT | |
|-----------|----------------------------------------------------------------------------------|
| Model | Magnetic connector accessory |
| Reference | A435-01- 00 W <input type="checkbox"/> N <input checked="" type="checkbox"/> |
| Category | Accessories |



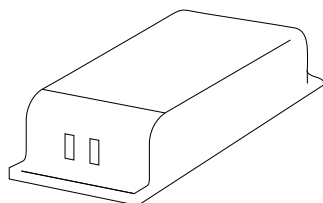

| | | | P | V | D (A x B x C) |
|------------------|--------|------------|------|-----|-----------------|
| 24V Power Supply | ON/OFF | 0434-01-37 | 60W | 24V | 180 x 52 x 30mm |
| | | 0433-10-22 | 100W | 24V | 295 x 43 x 30mm |

220 V~
240 V~

TO BE INSTALLED ON REMOTE

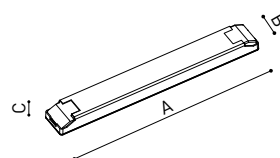

| | | | P | V | D (A x B x C) |
|------------|--|------------|-----------|-----|-----------------|
| 24V Dimmer | | 0433-01-32 | DALI/PUSH | 24V | 181 x 42 x 20mm |
| | | 0433-01-33 | CASAMBI | 24V | 172 x 42 x 20mm |
| | | 0434-01-64 | WIFI | 24V | 105 x 44 x 23mm |

24V

TO BE INSTALLED ON REMOTE

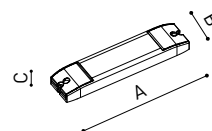

DROP VOLTAGE TABLE

| POWER (W) | CABLE SECTION (mm ²) | CABLE LENGTH (m) |
|-----------|----------------------------------|------------------|
| 60 | 0,75 | 30 |
| | 1,5 | 30 |
| 100 | 0,75 | 20 |
| | 1,5 | 30 |

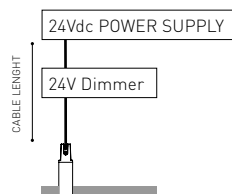



INSTALLATION GUIDE

https://youtu.be/sa_xAgj4ji4

PRODUCT

| | |
|-----------|-----------------------------------|
| Model | Trimless Tool D16 X D34 MM |
| Reference | A478-00-00 |
| Category | Accessories |

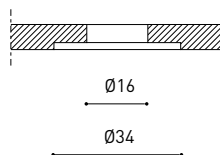
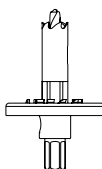



Fuente de luz (LED) reemplazable por un profesional autorizado

Replaceable (LED only) light source by an authorized professional.

Source lumineuse (LED) remplaçable par un professionnel agréé

Sorgente luminosa (LED) sostituibile da parte di un professionista autorizzato

Austauschbare (LED) Lichtquelle durch einen autorisierten Fachmann



Equipo de control reemplazable por un profesional autorizado

Replaceable control gear by an authorized professional

Dispositif de commande remplaçable par un professionnel agréé

Alimentatore sostituibile da parte di un professionista autorizzato

Auswechselbares Betriebsgerät durch autorisierten Fachmann

INSTRUCCIONES PARA EL FINAL DE VIDA Y LA ELIMINACIÓN LOS COMPONENTES
 INSTRUCTIONS ON END-OF-LIFE AND COMPONENT DISPOSAL
 INSTRUCTIONS POUR LA GESTION DES COMPOSANTS EN FIN DE VIE ET LEUR MISE AU REBUT
 ISTRUZIONI PER IL FINE VITA E LO SMALTIMENTO DEI COMPONENTI
 ANWEISUNGEN ZUR ENTSORGUNG DER LEUCHTENKOMPONENTEN



Interrumpir la alimentación del aparato
 Cut the power supply to the luminaire
 Couper l'alimentation du luminaire
 Interrompere l'alimentazione dell'apparecchio
 Stromversorgung der Leuchte unterbrechen



Quitar la(s) fuente(s) de luz para el desecho
 Remove light source(s) for disposal
 Retirer la (les) source(s) lumineuse(s) pour l'élimination
 Rimuovere la/le sorgente/e di luce per lo smaltimento
 Lichtquelle(n) zur Entsorgung entfernen



Quitar la batería para el desecho
 Remove the battery for decommissioning
 Retirer la batterie pour sa mise au rebut
 Rimuovere la batteria per la dismissione
 Die Batterie ordnungsgemäß entsorgen



Quitar el equipo de control para el desecho
 Remove control gear for disposal
 Retirer le dispositif de commande pour l'élimination
 Rimuovere l'alimentatore per lo smaltimento
 Betriebsgerät zur Entsorgung ausbauen



Enviar los materiales a un centro de recogida RAEE
 Send the materials to a WEEE collection centre
 Envoyer les matériaux dans une déchetterie DEEE
 Inviare i materiali ad un centro di raccolta RAEE
 Die Materialien in einem WEEE-Zentrum entsorgen

