

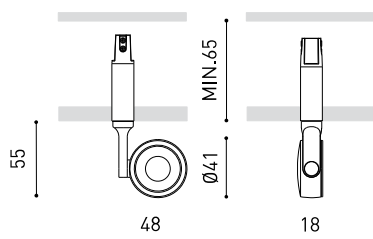

## DIMENSIONS



## ACCESSORIES



HIGH CHROMATIC LED



MAGNETIC CONNECTOR  
(MANDATORY)



DRIVER OPTIONS



TRIMLESS TOOL

## AWARDS



## PRODUCT

Name	MAGNETIC 24V SIX XS 23° 3000K WT
Reference	A4290121WT
Color	Textured white
RAL	9016
Category	CEILING RECESSED

## LIGHT SOURCE

Type	LED
Gross luminous flux	500 lm
Colour temperature	3000 K
Chromatic stability	MacAdam Step 2
Colour Rendering Index	CRI > 90
Power	4,5 W
Current	400 mA
Efficacy	111 lm/W
LED lifespan	L90B10 > 55.000h

## LIGHTING FIXTURE | PHOTOMETRIC DATA

Lighting efficiency	86%
Light beam angle	23°

## LIGHTING FIXTURE | ELECTRICAL DATA

Driver	Included
Power values of the system	5,14 W
Voltage	24Vdc
Dimming	No Dim
Electrical insulation class	II

## OTHER DATA

Sealing	IP20
Wireless control	Please Consult
Swivel angle	310°
Rotation angle	360°
Weight	50 g
Packaged weight	75 g
Packaging dimensions	112 x 80 x 32 mm
Units per package	1
Materials	Aluminium / Polycarbonate



Six Magnetic is a spotlight for single Magnetic lighting solutions that stands out for its elegance and airiness. Its body, disk looking, rounded shaped, encloses an innovative combination of reflector and lens. The combined action of both, allows Six to direct light rays with the maximum uniformity in a very small distance that, at the same time, has made possible its differential design—reduced and minimalist—. In addition, Six can be freely articulated due to its airy arm which allows the spotlight to be orientated in any direction.

POLAR DIAGRAM

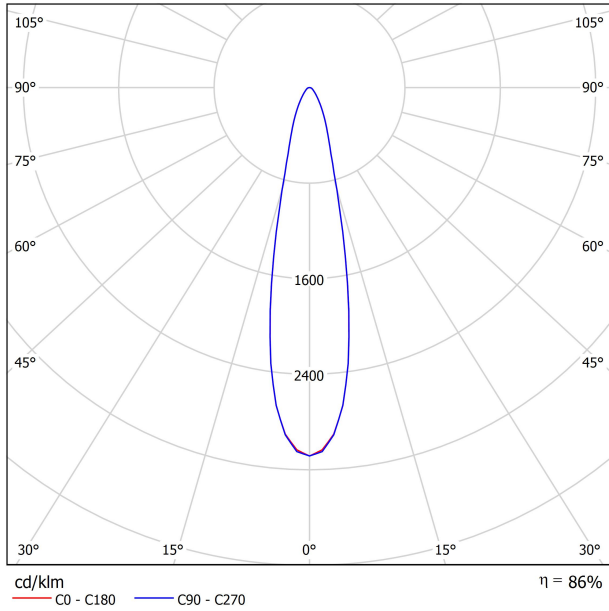

CONICAL DIAGRAM

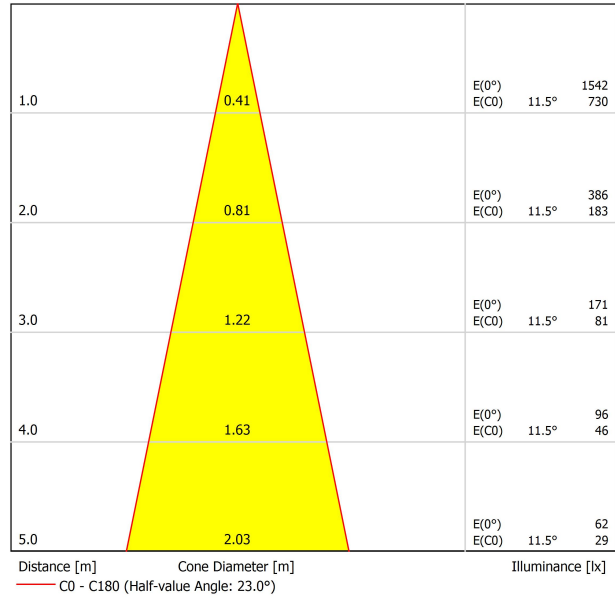

Vivid Model Colour Temperature	2700K	3000K	3500K	4000K	Light Pink
📖 Reading			•	•	
🥬 Fruits & Vegetables		•	•		
🍞 Bakery	•				
👤 Retail		•	•		
💄 Cosmetics			•	•	
🥩 Meat					•
🐟 Fish				•	
🐠 Seafood				•	•



For some of its products, Arkoslight offers the possibility to provide them with a special LED, designed to create an illumination focused on visually promoting goods or products for commercial purposes. It is a high chromaticity LED, capable of identifying the colour shades that produce a positive psychological perception of the illuminated object.

This special LED lighting source offers a much more attractive and intense colour range than a conventional LED, besides being much wider. Technically, this is possible thanks to a special LED setting that includes a «special saturation parameter», capable of highlighting the objects colours and materials in such a way that they seem more attractive within the visible light spectrum. To achieve this performance, in each case, the appropriate diode and specific phosphor coating are carefully selected.

# MAGNETIC 24V CONNECTOR

ARKOSLIGHT®

MANDATORY FOR INSTALLATION

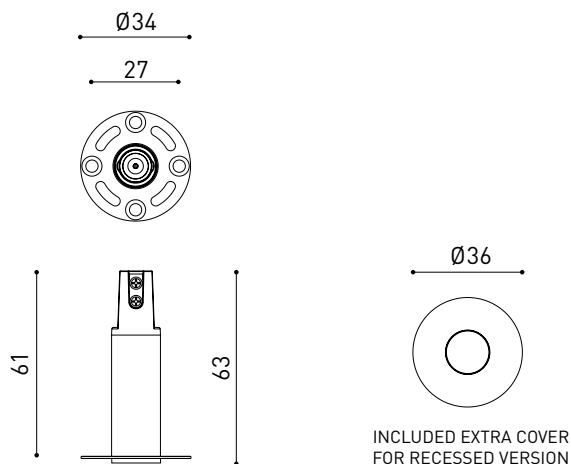

PRODUCT	
Model	Magnetic connector accessory
Reference	A435-01- 00   W <input type="checkbox"/>   N <input checked="" type="checkbox"/>
Category	Accessories



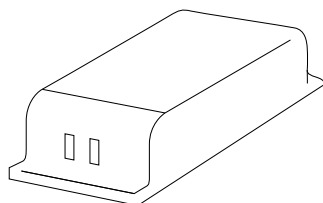

			P	V	D (A x B x C)
<b>24V Power Supply</b>	ON/OFF	<b>0434-01-37</b>	60W	24V	180 x 52 x 30mm
		<b>0433-10-22</b>	100W	24V	295 x 43 x 30mm
220 240 V~					TO BE INSTALLED ON REMOTE



			P	V	D (A x B x C)
<b>24V Dimmer</b>		<b>0433-01-32</b>	DALI/PUSH	24V	181 x 42 x 20mm
		<b>0433-01-33</b>	CASAMBI	24V	172 x 42 x 20mm
		<b>0434-01-64</b>	WIFI	24V	105 x 44 x 23mm
24V					TO BE INSTALLED ON REMOTE



**DROP VOLTAGE TABLE**

POWER (W)	CABLE SECTION (mm <sup>2</sup> )	CABLE LENGHT (m)
60	0,75	30
	1,5	30
100	0,75	20
	1,5	30





INSTALLATION GUIDE

[https://youtu.be/sa\\_xAgj4ji4](https://youtu.be/sa_xAgj4ji4)

## PRODUCT

Model	Trimless Tool <b>D16 X D34 MM</b>
Reference	A478-00-00
Category	Accessories

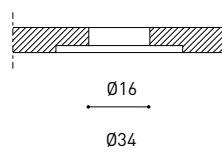
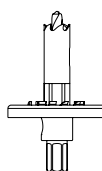



Fuente de luz (LED) reemplazable por un profesional autorizado  
 Replaceable (LED only) light source by an authorized professional.  
 Source lumineuse (LED) remplaçable par un professionnel agréé  
 Sorgente luminosa (LED) sostituibile da parte di un professionista autorizzato  
 Austauschbare (LED) Lichtquelle durch einen autorisierten Fachmann



Equipo de control reemplazable por un profesional autorizado  
 Replaceable control gear by an authorized professional  
 Dispositif de commande remplaçable par un professionnel agréé  
 Alimentatore sostituibile da parte di un professionista autorizzato  
 Auswechselbares Betriebsgerät durch autorisierten Fachmann

INSTRUCCIONES PARA EL FINAL DE VIDA Y LA ELIMINACIÓN LOS COMPONENTES  
 INSTRUCTIONS ON END-OF-LIFE AND COMPONENT DISPOSAL  
 INSTRUCTIONS POUR LA GESTION DES COMPOSANTS EN FIN DE VIE ET LEUR MISE AU REBUT  
 ISTRUZIONI PER IL FINE VITA E LO SMALTIMENTO DEI COMPONENTI  
 ANWEISUNGEN ZUR ENTSORGUNG DER LEUCHTENKOMPONENTEN



Interrumpir la alimentación del aparato  
 Cut the power supply to the luminaire  
 Couper l'alimentation du luminaire  
 Interrompere l'alimentazione dell'apparecchio  
 Stromversorgung der Leuchte unterbrechen



Quitar la(s) fuente(s) de luz para el desecho  
 Remove light source(s) for disposal  
 Retirer la (les) source(s) lumineuse(s) pour l'élimination  
 Rimuovere la/le sorgente/e di luce per lo smaltimento  
 Lichtquelle(n) zur Entsorgung entfernen



Quitar la batería para el desecho  
 Remove the battery for decommissioning  
 Retirer la batterie pour sa mise au rebut  
 Rimuovere la batteria per la dismissione  
 Die Batterie ordnungsgemäß entsorgen



Quitar el equipo de control para el desecho  
 Remove control gear for disposal  
 Retirer le dispositif de commande pour l'élimination  
 Rimuovere l'alimentatore per lo smaltimento  
 Betriebsgerät zur Entsorgung ausbauen

Enviar los materiales a un centro de recogida RAEE  
 Send the materials to a WEEE collection centre  
 Envoyer les matériaux dans une déchetterie DEEE  
 Inviare i materiali ad un centro di raccolta RAEE  
 Die Materialien in einem WEEE-Zentrum entsorgen

