

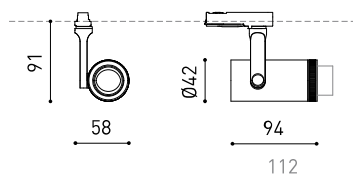

DIMENSIONS



ACCESSORIES



HIGH CHROMATIC LED



TRACK 1L OPTIONS

AWARDS



PRODUCT

Name	PLUS MINI 1L 4000K WT
Reference	A3270022WT
Color	Textured white
RAL	9016
Category	TRACKLIGHTS

LIGHT SOURCE

Type	LED
Gross luminous flux	515 lm
Colour temperature	4000 K
Chromatic stability	MacAdam Step 2
Colour Rendering Index	CRI > 90
Power	4,5 W
Current	500 mA
Efficacy	114 lm/W
LED lifespan	L90B10 > 55.000h

LIGHTING FIXTURE | PHOTOMETRIC DATA

Lighting efficiency	20-40%
Light beam angle	10°-41°

LIGHTING FIXTURE | ELECTRICAL DATA

Driver	Included
Power values of the system	6,34 W
Voltage	220V/240V
Frecuency	50/60 Hz
Dimming	No Dim
Electrical insulation class	⊕

OTHER DATA

Sealing	IP20
Swivel angle	180°
Rotation angle	350°
Track type	Track 1L
Weight	237 g
Packaged weight	320 g
Packaging dimensions	199 x 162 x 63 mm
Units per package	1
Materials	Aluminium / Optical Polymethyl Methacrylate



Plus Mini 1L is a miniaturised spotlight for monophasic track applications which offers the possibility of expanding or concentrating the beam light with just a smooth manual gesture. This characteristic makes Plus the ideal alternative for applications where the precision within the beam of light is essential- like for example: museums, exhibitions, retail or accent lighting applications.



POLAR DIAGRAM



cd/klm

— C0 - C180    — C90 - C270

CONICAL DIAGRAM

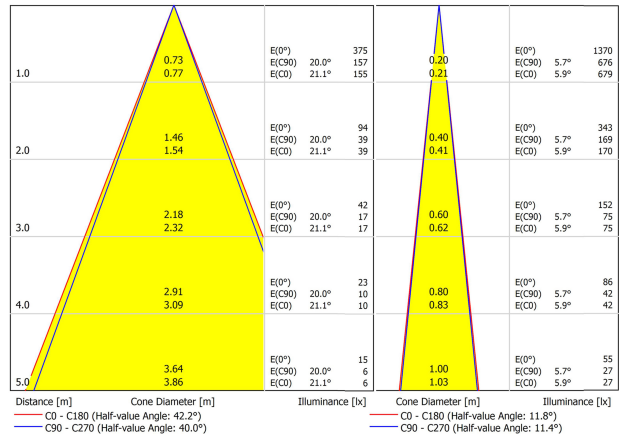

Vivid Model Colour Temperature	2700K	3000K	3500K	4000K	Light Pink
📖 Reading			•	•	
🥬 Fruits & Vegetables		•	•		
🍞 Bakery	•				
👤 Retail		•	•		
💄 Cosmetics			•	•	
🥩 Meat					•
🐟 Fish				•	
🐠 Seafood				•	•



For some of its products, Arkoslight offers the possibility to provide them with a special LED, designed to create an illumination focused on visually promoting goods or products for commercial purposes. It is a high chromaticity LED, capable of identifying the colour shades that produce a positive psychological perception of the illuminated object.

This special LED lighting source offers a much more attractive and intense colour range than a conventional LED, besides being much wider. Technically, this is possible thanks to a special LED setting that includes a «special saturation parameter», capable of highlighting the objects colours and materials in such a way that they seem more attractive within the visible light spectrum. To achieve this performance, in each case, the appropriate diode and specific phosphor coating are carefully selected.

SURFACE & SUSPENDED

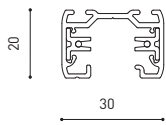

TRACK 1L 1m	A264-01-00-   B   N
TRACK 1L 2m	A264-02-00-   B   N
TRACK 1L 3m	A264-03-00-   B   N



POLARITY GROOVE

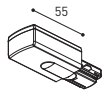

	<b>TRACK 1L Live-End Connector</b>
	A264-00-01-   B   N
	A264-00-02-   B   N

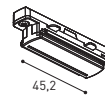

	<b>TRACK 1L Contact Joint</b>
	A264-00-04-   B   N

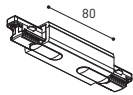

	<b>TRACK 1L Central Connector</b>
	A264-00-03-   B   N



	<b>TRACK 1L End</b>
	A264-00-13-   B   N

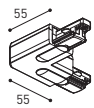

	<b>TRACK 1L 90° Angle</b>
	A264-00-06-   B   N
	A264-00-07-   B   N

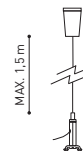

	<b>TRACK 1L Suspension Kit</b>
	A264-00-14-   WT   NT
	At least 2 units needed

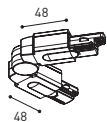

	<b>TRACK 1L Corner connector</b>
	A264-00-15-   B   N

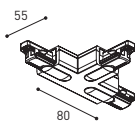

	<b>TRACK 1L T-Joint</b>
	A264-00-16-   B   N
	A264-00-17-   B   N

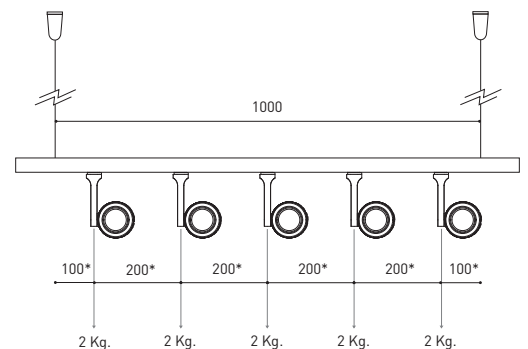

\*minimum distance (mm.)

COLOUR | B □ RAL 9016 | N ■ RAL 9005 | WT □ RAL 9016 | NT ■ RAL 9005 |

FLUSH MOUNTING

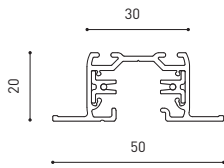
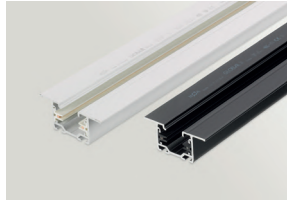

TRACK 1L FLUSH 1m	A264-11-00-   B   N
TRACK 1L FLUSH 2m	A264-12-00-   B   N
TRACK 1L FLUSH 3m	A264-13-00-   B   N



POLARITY GROOVE

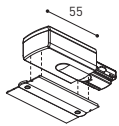

TRACK 1L FLUSH Live-End Connector

A264-00-01-   B   N
A264-00-02-   B   N

TRACK 1L FLUSH Cover Plate

A264-10-19-   B   N
---------------------

Mandatory for installation

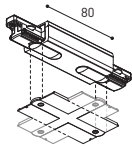

TRACK 1L FLUSH Central Connector

A264-00-03-   B   N
---------------------

TRACK 1L FLUSH Corner Cover Plate

A264-10-20-   B   N
---------------------

Mandatory for installation

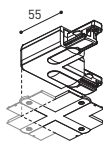

TRACK 1L FLUSH 90° Angle

A264-00-06-   B   N
A264-00-07-   B   N

TRACK 1L FLUSH Corner Cover Plate

A264-10-20-   B   N
---------------------

Mandatory for installation

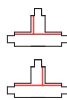
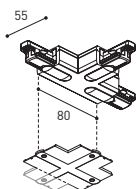

TRACK 1L FLUSH T-Joint

A264-00-16-   B   N
A264-00-17-   B   N

TRACK 1L FLUSH Corner Cover Plate

A264-10-20-   B   N
---------------------

Mandatory for installation

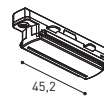

TRACK 1L Contact Joint

A264-00-04-   B   N
---------------------



TRACK 1L End

A264-00-13-   B   N
---------------------



TRACK 1L FLUSH Suspension Kit

A264-10-15
------------

For wire 1,5 mm [Not included]

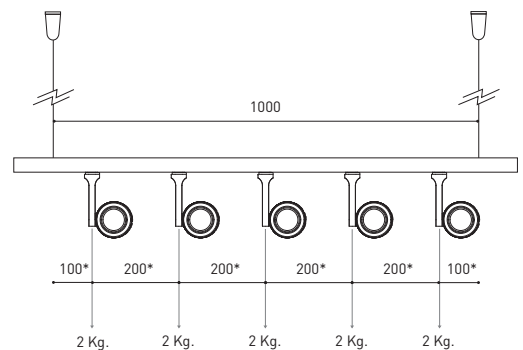

\*minimum distance [mm.]

COLOUR | B □ RAL 9016 | N ■ RAL 9005 |



Fuente de luz (LED) reemplazable por un profesional autorizado

Replaceable (LED only) light source by an authorized professional.

Source lumineuse (LED) remplaçable par un professionnel agréé

Sorgente luminosa (LED) sostituibile da parte di un professionista autorizzato

Austauschbare (LED) Lichtquelle durch einen autorisierten Fachmann



Equipo de control reemplazable por un profesional autorizado

Replaceable control gear by an authorized professional

Dispositif de commande remplaçable par un professionnel agréé

Alimentatore sostituibile da parte di un professionista autorizzato

Auswechselbares Betriebsgerät durch autorisierten Fachmann

INSTRUCCIONES PARA EL FINAL DE VIDA Y LA ELIMINACIÓN LOS COMPONENTES  
 INSTRUCTIONS ON END-OF-LIFE AND COMPONENT DISPOSAL  
 INSTRUCTIONS POUR LA GESTION DES COMPOSANTS EN FIN DE VIE ET LEUR MISE AU REBUT  
 ISTRUZIONI PER IL FINE VITA E LO SMALTIMENTO DEI COMPONENTI  
 ANWEISUNGEN ZUR ENTSORGUNG DER LEUCHTENKOMPONENTEN



Interrumpir la alimentación del aparato  
 Cut the power supply to the luminaire  
 Couper l'alimentation du luminaire  
 Interrompere l'alimentazione dell'apparecchio  
 Stromversorgung der Leuchte unterbrechen



Quitar la(s) fuente(s) de luz para el desecho  
 Remove light source(s) for disposal  
 Retirer la (les) source(s) lumineuse(s) pour l'élimination  
 Rimuovere la/le sorgente/e di luce per lo smaltimento  
 Lichtquelle(n) zur Entsorgung entfernen



Quitar la batería para el desecho  
 Remove the battery for decommissioning  
 Retirer la batterie pour sa mise au rebut  
 Rimuovere la batteria per la dismissione  
 Die Batterie ordnungsgemäß entsorgen



Quitar el equipo de control para el desecho  
 Remove control gear for disposal  
 Retirer le dispositif de commande pour l'élimination  
 Rimuovere l'alimentatore per lo smaltimento  
 Betriebsgerät zur Entsorgung ausbauen



Enviar los materiales a un centro de recogida RAEE  
 Send the materials to a WEEE collection centre  
 Envoyer les matériaux dans une déchetterie DEEE  
 Inviare i materiali ad un centro di raccolta RAEE  
 Die Materialien in einem WEEE-Zentrum entsorgen

