

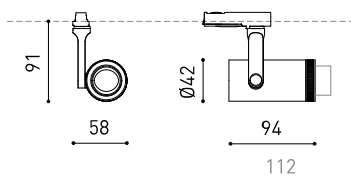

DIMENSIONES



ACCESORIOS



HIGH CHROMATIC LED



TRACK 1L OPTIONS

PREMIOS



Nombre	PLUS MINI 1L 3000K NT
Referencia	A3270021NT
Color	Negro Texturado
RAL	9005
Categoría	TRACKLIGHTS

PRODUCTO

FUENTE DE LUZ

Tipo	LED
Flujo Luminoso	500 lm
Temperatura de color	3000 K
Estabilidad cromática	MacAdam Step 2
Índice de reproducción cromática	CRI > 90
Potencia	4,5 W
Corriente	500 mA
Eficacia	111 lm/W
Horas de Vida del LED	L90B10 > 55.000h

LUMINARIA | DATOS FOTOMÉTRICOS

Eficiencia Lumínica	20-40%
Ángulo del haz de luz	10°-41°

LUMINARIA | DATOS ELÉCTRICOS

Driver	Incluido
Potencia del sistema	6,34 W
Tensión	220V/240V
Frecuencia	50/60 Hz
Regulación	No Dim
Clase de seguridad eléctrica	⚡

OTROS DATOS

Estanqueidad	IP20
Ángulo de basculación	180°
Ángulo de giro	350°
Tipo de carril	Track 1L
Peso	237 g
Peso con embalaje	320 g
Dimensiones embalaje	199 x 162 x 63 mm
Unidades por embalaje	1
Materiales	Aluminio / Polimetilmetacrilato Óptico



Plus Mini 1L es un proyector miniaturizado, destinado a carril monofásico, que ofrece la capacidad de ampliar o concentrar la apertura del haz de luz con un suave movimiento manual. Esta característica hace a Plus el proyector ideal para aplicaciones donde la precisión del haz de luz es un elemento esencial, tales como museos, exposiciones, retail o aplicaciones de acento.



DIAGRAMA POLAR



cd/klm
 — C0 - C180 — C90 - C270

DIAGRAMA CÓNICO

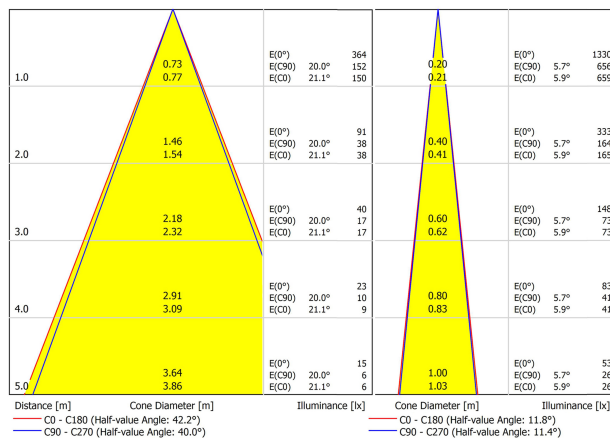

PARA PRESENTACIÓN COMERCIAL DE PRODUCTO

Vivid Model Colour Temperature	2700K	3000K	3500K	4000K	Light Pink
📖 Reading			•	•	
🥗 Fruits & Vegetables		•	•		
🍞 Bakery	•				
👤 Retail		•	•		
💄 Cosmetics			•	•	
🥩 Meat					•
🐟 Fish				•	
🐠 Seafood				•	•



Arkosligh ofrece en algunos de sus productos la posibilidad de dotarlos de un LED especial para iluminación orientada a la promoción visual de bienes y productos con finalidad comercial.

Se trata de un LED de alta cromaticidad que persigue destacar los tonos que favorecen la percepción psicológica positiva del objeto iluminado.

Esta fuente de luz LED especial ofrece una paleta de colores más atractiva e intensa, por encima de lo que lo hace un LED convencional. Esto se consigue gracias a la configuración del LED bajo un "parámetro especial de saturación" que consigue que los colores y la textura de los objetos se muestren más atractivos dentro del espectro de luz visible. Para ello se selecciona, en cada caso, el diodo pertinente y su fósforo de recubrimiento específico.

SURFACE & SUSPENDED

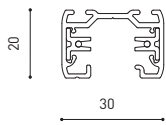

TRACK 1L 1m	A264-01-00- B N
TRACK 1L 2m	A264-02-00- B N
TRACK 1L 3m	A264-03-00- B N



POLARITY GROOVE

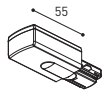

	TRACK 1L Live-End Connector
	A264-00-01- B N
	A264-00-02- B N

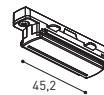

	TRACK 1L Contact Joint
	A264-00-04- B N

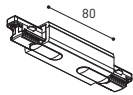

	TRACK 1L Central Connector
	A264-00-03- B N



	TRACK 1L End
	A264-00-13- B N

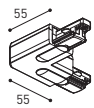

	TRACK 1L 90° Angle
	A264-00-06- B N
	A264-00-07- B N

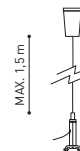

	TRACK 1L Suspension Kit
	A264-00-14- WT NT
	At least 2 units needed

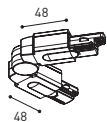

	TRACK 1L Corner connector
	A264-00-15- B N

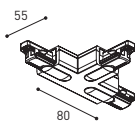

	TRACK 1L T-Joint
	A264-00-16- B N
	A264-00-17- B N

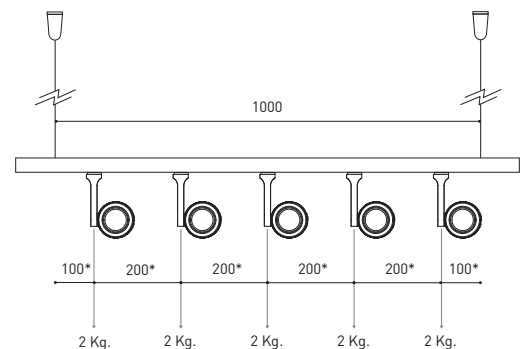

*minimum distance (mm.)

COLOUR | B □ RAL 9016 | N ■ RAL 9005 | WT □ RAL 9016 | NT ■ RAL 9005 |

FLUSH MOUNTING

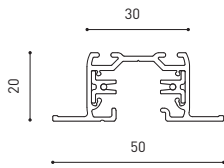
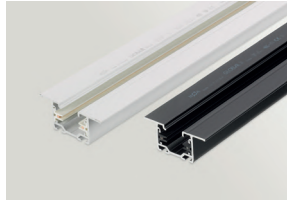

TRACK 1L FLUSH 1m	A264-11-00- B N
TRACK 1L FLUSH 2m	A264-12-00- B N
TRACK 1L FLUSH 3m	A264-13-00- B N



POLARITY GROOVE

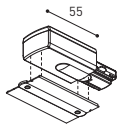

TRACK 1L FLUSH Live-End Connector

A264-00-01- B N
A264-00-02- B N

TRACK 1L FLUSH Cover Plate

A264-10-19- B N

Mandatory for installation

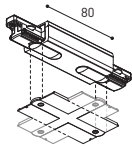

TRACK 1L FLUSH Central Connector

A264-00-03- B N

TRACK 1L FLUSH Corner Cover Plate

A264-10-20- B N

Mandatory for installation

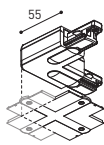

TRACK 1L FLUSH 90° Angle

A264-00-06- B N
A264-00-07- B N

TRACK 1L FLUSH Corner Cover Plate

A264-10-20- B N

Mandatory for installation

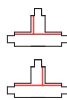
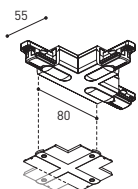

TRACK 1L FLUSH T-Joint

A264-00-16- B N
A264-00-17- B N

TRACK 1L FLUSH Corner Cover Plate

A264-10-20- B N

Mandatory for installation

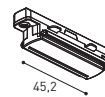

TRACK 1L Contact Joint

A264-00-04- B N



TRACK 1L End

A264-00-13- B N



TRACK 1L FLUSH Suspension Kit

A264-10-15

For wire 1,5 mm [Not included]

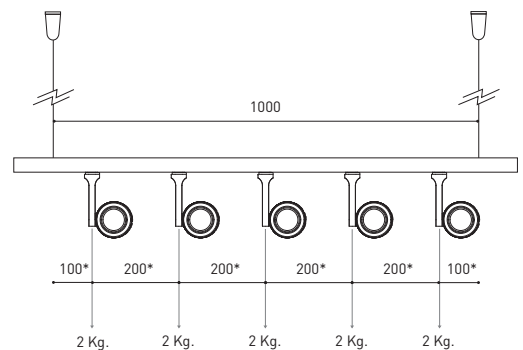

*minimum distance [mm.]

COLOUR | B □ RAL 9016 | N ■ RAL 9005 |



Fuente de luz (LED) reemplazable por un profesional autorizado

Replaceable (LED only) light source by an authorized professional.

Source lumineuse (LED) remplaçable par un professionnel agréé

Sorgente luminosa (LED) sostituibile da parte di un professionista autorizzato

Austauschbare (LED) Lichtquelle durch einen autorisierten Fachmann



Equipo de control reemplazable por un profesional autorizado

Replaceable control gear by an authorized professional

Dispositif de commande remplaçable par un professionnel agréé

Alimentatore sostituibile da parte di un professionista autorizzato

Auswechselbares Betriebsgerät durch autorisierten Fachmann

INSTRUCCIONES PARA EL FINAL DE VIDA Y LA ELIMINACIÓN LOS COMPONENTES
 INSTRUCTIONS ON END-OF-LIFE AND COMPONENT DISPOSAL
 INSTRUCTIONS POUR LA GESTION DES COMPOSANTS EN FIN DE VIE ET LEUR MISE AU REBUT
 ISTRUZIONI PER IL FINE VITA E LO SMALTIMENTO DEI COMPONENTI
 ANWEISUNGEN ZUR ENTSORGUNG DER LEUCHTENKOMPONENTEN



Interrumpir la alimentación del aparato
 Cut the power supply to the luminaire
 Couper l'alimentation du luminaire
 Interrompere l'alimentazione dell'apparecchio
 Stromversorgung der Leuchte unterbrechen



Quitar la(s) fuente(s) de luz para el desecho
 Remove light source(s) for disposal
 Retirer la (les) source(s) lumineuse(s) pour l'élimination
 Rimuovere la/le sorgente/e di luce per lo smaltimento
 Lichtquelle(n) zur Entsorgung entfernen



Quitar la batería para el desecho
 Remove the battery for decommissioning
 Retirer la batterie pour sa mise au rebut
 Rimuovere la batteria per la dismissione
 Die Batterie ordnungsgemäß entsorgen



Quitar el equipo de control para el desecho
 Remove control gear for disposal
 Retirer le dispositif de commande pour l'élimination
 Rimuovere l'alimentatore per lo smaltimento
 Betriebsgerät zur Entsorgung ausbauen



Enviar los materiales a un centro de recogida RAEE
 Send the materials to a WEEE collection centre
 Envoyer les matériaux dans une déchetterie DEEE
 Inviare i materiali ad un centro di raccolta RAEE
 Die Materialien in einem WEEE-Zentrum entsorgen

