

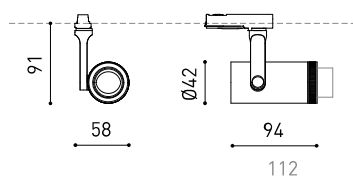

GRÖÖE



ZUBEHÖR



HIGH CHROMATIC LED



TRACK 1L OPTIONS

PREISE

PREMIO
ADCV 2019
ORO



PRODUKT

| | |
|---------------|-----------------------|
| Name | PLUS MINI 1L 2700K WT |
| Artikelnummer | A3270020WT |
| Farbe | Weiß strukturiert |
| RAL | 9016 |
| Kategorie | TRACKLIGHTS |

LICHTQUELLE

| | |
|--|------------------|
| Typ | LED |
| Bruttolichtstrom | 480 lm |
| Farbtemperatur | 2700 K |
| Farbstabilität | MacAdam Step 2 |
| Farbwiedergabeindex | CRI > 90 |
| Leistung | 4,5 W |
| Stromstärke | 500 mA |
| Lichtausbeute | 107 lm/W |
| Nutzlebensdauer der LED in Betriebsstunden | L90B10 > 55.000h |

LEUCHE | PHOTOMETRISCHE DATEN

| | |
|----------------------------|---------|
| Leuchtenwirkungsgrad (LOR) | 20-40% |
| Abstrahlwinkel | 10°-41° |

LEUCHE | ELEKTRISCHE DATEN

| | |
|----------------------------|-----------|
| Driver | Inklusiv |
| Leistungswerte des Systems | 6,34 W |
| Spannung | 220V/240V |
| Frequenz | 50/60 Hz |
| Helligkeitssteuerung | No Dim |
| Schutzklasse | ⚡ |

ANDERE DATEN

| | |
|----------------------------|--|
| Dichtigkeit | IP20 |
| Schwenkwinkel | 180° |
| Drehwinkel | 350° |
| Schiennentyp | Track 1L |
| Gewicht | 237 g |
| Gewicht inkl. Verpackung | 320 g |
| Abmessungen der Verpackung | 199 x 162 x 63 mm |
| Stück pro Verpackung | 1 |
| Materialien | Aluminium / Optical Polymethylmetacrylat |



Plus Mini 1L ist ein miniaturisierter Strahler, der für eine einphasige Schiene gedacht ist und die Möglichkeit bietet, die Öffnung des Lichtstrahls mit einer leichten manuellen Bewegung zu erweitern oder zu konzentrieren. Diese Funktion macht Plus zum idealen Projektor für Anwendungen, bei denen die Präzision des Lichtstrahls ein wesentliches Element ist, wie z. B. Museen, Ausstellungen, Einzelhandel oder Akzentanwendungen.

POLAR-KOORDINATEN DIAGRAMM



cd/klm
 — C0 - C180 — C90 - C270

KEGELDIAGRAMM

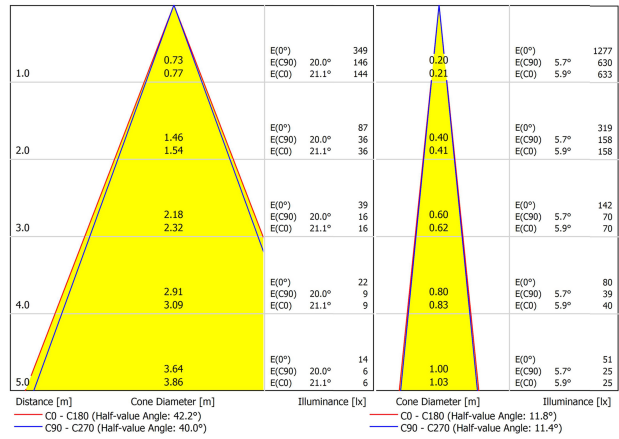

FÜR DIE PRODUKTPRÄSENTATION

| Vivid Model Colour Temperature | 2700K | 3000K | 3500K | 4000K | Light Pink |
|-----------------------------------|-------|-------|-------|-------|------------|
| 📖 Reading | | | • | • | |
| 🥬 Fruits & Vegetables | | • | • | | |
| 🍞 Bakery | • | | | | |
| 👤 Retail | | • | • | | |
| 💄 Cosmetics | | | • | • | |
| 🥩 Meat | | | | | • |
| 🐟 Fish | | | | • | |
| 🐠 Seafood | | | | • | • |



Einige der Produkte von Arkoslight können mit einer Spezial-LED für die visuelle Bewerbung von Waren und Produkten zur Verkaufsförderung ausgerüstet werden.

Dabei handelt es sich um eine hochchromatische LED, um Farbtöne hervorzuheben, die positive psychologische Wahrnehmung des beleuchteten Objekts begünstigen.

Diese spezielle LED-Lichtquelle bietet eine ansprechendere und intensivere Farbpalette als eine herkömmliche LED. Dies wird durch die Konfiguration der LED nach einem "speziellen Sättigungsparameter" erreicht, der Farben und Textur der Objekte innerhalb des sichtbaren Spektralbereichs attraktiver erscheinen lässt. Dafür wird die jeweils zweckdienliche Diode und spezifische Phosphorbeschichtung gewählt.

SURFACE & SUSPENDED

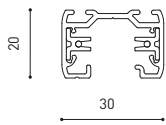

| | |
|-------------|---------------------|
| TRACK 1L 1m | A264-01-00- B N |
| TRACK 1L 2m | A264-02-00- B N |
| TRACK 1L 3m | A264-03-00- B N |



POLARITY GROOVE

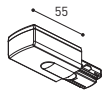

| | |
|--|------------------------------------|
| | TRACK 1L Live-End Connector |
| | A264-00-01- B N |
| | A264-00-02- B N |

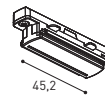

| | |
|--|-------------------------------|
| | TRACK 1L Contact Joint |
| | A264-00-04- B N |

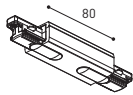

| | |
|--|-----------------------------------|
| | TRACK 1L Central Connector |
| | A264-00-03- B N |



| | |
|--|---------------------|
| | TRACK 1L End |
| | A264-00-13- B N |

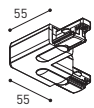

| | |
|--|---------------------------|
| | TRACK 1L 90° Angle |
| | A264-00-06- B N |
| | A264-00-07- B N |

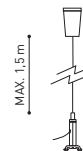

| | |
|--|--------------------------------|
| | TRACK 1L Suspension Kit |
| | A264-00-14- WT NT |
| | At least 2 units needed |

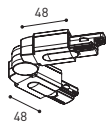

| | |
|--|----------------------------------|
| | TRACK 1L Corner connector |
| | A264-00-15- B N |

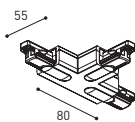

| | |
|--|-------------------------|
| | TRACK 1L T-Joint |
| | A264-00-16- B N |
| | A264-00-17- B N |

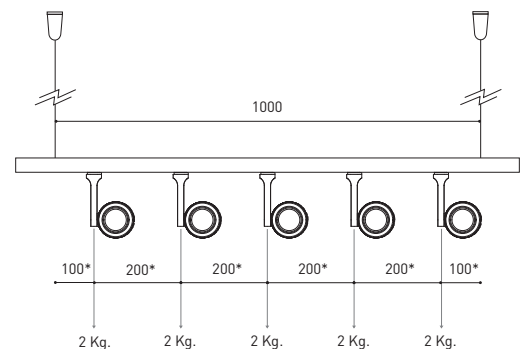

*minimum distance (mm.)

COLOUR | B □ RAL 9016 | N ■ RAL 9005 | WT □ RAL 9016 | NT ■ RAL 9005 |

FLUSH MOUNTING

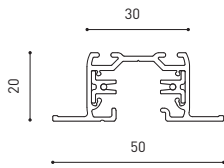
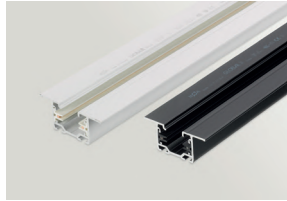

| | |
|-------------------|---------------------|
| TRACK 1L FLUSH 1m | A264-11-00- B N |
| TRACK 1L FLUSH 2m | A264-12-00- B N |
| TRACK 1L FLUSH 3m | A264-13-00- B N |



POLARITY GROOVE

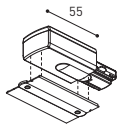

TRACK 1L FLUSH Live-End Connector

| |
|---------------------|
| A264-00-01- B N |
| A264-00-02- B N |

TRACK 1L FLUSH Cover Plate

| |
|---------------------|
| A264-10-19- B N |
|---------------------|

Mandatory for installation

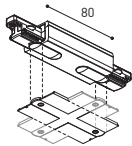

TRACK 1L FLUSH Central Connector

| |
|---------------------|
| A264-00-03- B N |
|---------------------|

TRACK 1L FLUSH Corner Cover Plate

| |
|---------------------|
| A264-10-20- B N |
|---------------------|

Mandatory for installation

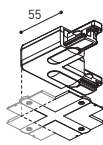

TRACK 1L FLUSH 90° Angle

| |
|---------------------|
| A264-00-06- B N |
| A264-00-07- B N |

TRACK 1L FLUSH Corner Cover Plate

| |
|---------------------|
| A264-10-20- B N |
|---------------------|

Mandatory for installation

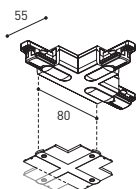

TRACK 1L FLUSH T-Joint

| |
|---------------------|
| A264-00-16- B N |
| A264-00-17- B N |

TRACK 1L FLUSH Corner Cover Plate

| |
|---------------------|
| A264-10-20- B N |
|---------------------|

Mandatory for installation

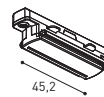

TRACK 1L Contact Joint

| |
|---------------------|
| A264-00-04- B N |
|---------------------|



TRACK 1L End

| |
|---------------------|
| A264-00-13- B N |
|---------------------|



TRACK 1L FLUSH Suspension Kit

| |
|------------|
| A264-10-15 |
|------------|

For wire 1,5 mm [Not included]

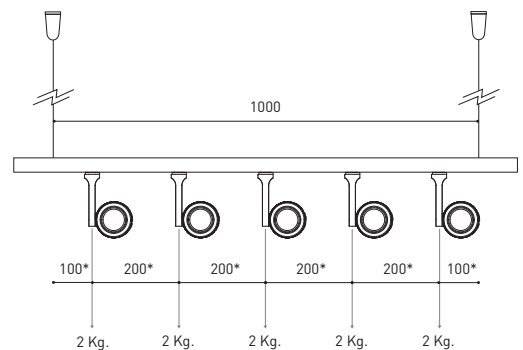

*minimum distance [mm.]

COLOUR | B □ RAL 9016 | N ■ RAL 9005 |



Fuente de luz (LED) reemplazable por un profesional autorizado

Replaceable (LED only) light source by an authorized professional.

Source lumineuse (LED) remplaçable par un professionnel agréé

Sorgente luminosa (LED) sostituibile da parte di un professionista autorizzato

Austauschbare (LED) Lichtquelle durch einen autorisierten Fachmann



Equipo de control reemplazable por un profesional autorizado

Replaceable control gear by an authorized professional

Dispositif de commande remplaçable par un professionnel agréé

Alimentatore sostituibile da parte di un professionista autorizzato

Auswechselbares Betriebsgerät durch autorisierten Fachmann

INSTRUCCIONES PARA EL FINAL DE VIDA Y LA ELIMINACIÓN LOS COMPONENTES
 INSTRUCTIONS ON END-OF-LIFE AND COMPONENT DISPOSAL
 INSTRUCTIONS POUR LA GESTION DES COMPOSANTS EN FIN DE VIE ET LEUR MISE AU REBUT
 ISTRUZIONI PER IL FINE VITA E LO SMALTIMENTO DEI COMPONENTI
 ANWEISUNGEN ZUR ENTSORGUNG DER LEUCHTENKOMPONENTEN



Interrumpir la alimentación del aparato
 Cut the power supply to the luminaire
 Couper l'alimentation du luminaire
 Interrompere l'alimentazione dell'apparecchio
 Stromversorgung der Leuchte unterbrechen



Quitar la(s) fuente(s) de luz para el desecho
 Remove light source(s) for disposal
 Retirer la (les) source(s) lumineuse(s) pour l'élimination
 Rimuovere la/le sorgente/e di luce per lo smaltimento
 Lichtquelle(n) zur Entsorgung entfernen



Quitar la batería para el desecho
 Remove the battery for decommissioning
 Retirer la batterie pour sa mise au rebut
 Rimuovere la batteria per la dismissione
 Die Batterie ordnungsgemäß entsorgen



Quitar el equipo de control para el desecho
 Remove control gear for disposal
 Retirer le dispositif de commande pour l'élimination
 Rimuovere l'alimentatore per lo smaltimento
 Betriebsgerät zur Entsorgung ausbauen



Enviar los materiales a un centro de recogida RAEE
 Send the materials to a WEEE collection centre
 Envoyer les matériaux dans une déchetterie DEEE
 Inviare i materiali ad un centro di raccolta RAEE
 Die Materialien in einem WEEE-Zentrum entsorgen

