

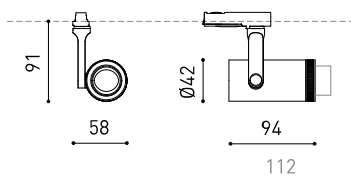

## DIMENSIONI



## ACCESSORI



HIGH CHROMATIC LED



TRACK 1L OPTIONS

## PREMI

PREMIO  
ADCV 2019  
ORO



## PRODOTTO

Nome	PLUS MINI 1L 2700K NT
Articolo	A3270020NT
Colore	Nero Strutturato
RAL	9005
Categoria	TRACKLIGHTS

## SORGENTE DI LUCE

Tipo	LED
Flusso luminoso lordo	480 lm
Temperatura di colore	2700 K
Stabilità cromatica	MacAdam Step 2
Indice di Riproduzione Cromatica	CRI > 90
Potenza	4,5 W
Corrente	500 mA
Efficienza	107 lm/W
Ore di vita del LED	L90B10 > 55.000h

## APPARECCHIO | DATI FOTOMETRICI

Efficienza luminosa	20-40%
Angolo del fascio di luce	10°-41°

## APPARECCHIO | DATI ELETTRICI

Driver	Incluso
Valori di potenza del sistema	6,34 W
Tensione	220V/240V
Frequenza	50/60 Hz
Regolazione	No Dim
Classe di isolamento elettrico	⊕

## ALTRI DATI

Tenuta stagna	IP20
Angolo di oscillazione	180°
Angolo di rotazione	350°
Tipo di binario	Track 1L
Peso	237 g
Peso compresso l'imballaggio	320 g
Dimensioni dell'imballaggio	199 x 162 x 63 mm
Unità per imballaggio	1
Materiali	Alluminio / Polimetilmetacrilato Ottico



Plus Mini 1L è un proiettore miniaturizzato che offre la possibilità di ampliare o ridurre il raggio di luce con un leggero intervento manuale. Questa caratteristica rende il Plus il proiettore ideale per applicazioni dove la precisione nel fascio di illuminazione è fondamentale, installazione di punta in musei, esposizioni, retail e ogni installazione che necessita enfasi.

DIAGRAMMA DI ABBAGLIAMENTO POLARE



cd/klm  
 — C0 - C180 — C90 - C270

DIAGRAMMA CONICO

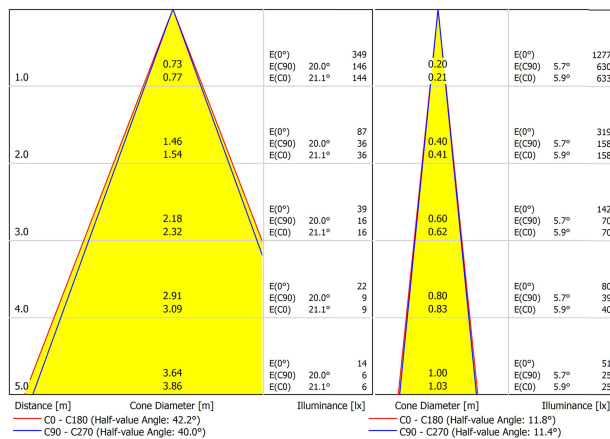

PER PRESENTAZIONE COMMERCIALE DEL PRODOTTO

Vivid Model Colour Temperature	2700K	3000K	3500K	4000K	Light Pink
📖 Reading			•	•	
🥬 Fruits & Vegetables		•	•		
🍞 Bakery	•				
👤 Retail		•	•		
💄 Cosmetics			•	•	
🥩 Meat					•
🐟 Fish				•	
🐠 Seafood				•	•



Arkoslight offre su alcuni dei suoi prodotti la possibilità di dotarli di un LED speciale per illuminazione orientata alla promozione visiva di beni e prodotti a scopo commerciale.

Si tratta di un LED ad alta cromaticità che mette in rilievo le tonalità che favoriscono la percezione psicologica positiva dell'oggetto illuminato.

Questa sorgente di luce LED speciale offre una gamma di colori più attraenti e intensi, superiore a quella che può offrire un LED convenzionale. Ciò si ottiene grazie alla configurazione del LED secondo un "parametro speciale di saturazione" che fa in modo che i colori e la texture degli oggetti appaiano più attraenti all'interno dello spettro di luce visibile. A tale scopo si seleziona, in ciascun caso, l'apposito diodo e il suo fosforo di rivestimento specifico.

SURFACE & SUSPENDED

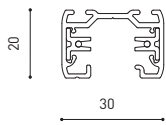

TRACK 1L 1m	A264-01-00-   B   N
TRACK 1L 2m	A264-02-00-   B   N
TRACK 1L 3m	A264-03-00-   B   N



POLARITY GROOVE

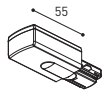

	<b>TRACK 1L Live-End Connector</b>
	A264-00-01-   B   N
	A264-00-02-   B   N

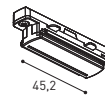

	<b>TRACK 1L Contact Joint</b>
	A264-00-04-   B   N

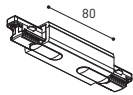

	<b>TRACK 1L Central Connector</b>
	A264-00-03-   B   N



	<b>TRACK 1L End</b>
	A264-00-13-   B   N

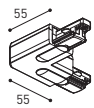

	<b>TRACK 1L 90° Angle</b>
	A264-00-06-   B   N
	A264-00-07-   B   N

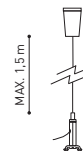

	<b>TRACK 1L Suspension Kit</b>
	A264-00-14-   WT   NT
<small>At least 2 units needed</small>	

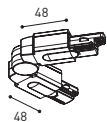

	<b>TRACK 1L Corner connector</b>
	A264-00-15-   B   N

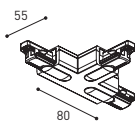

	<b>TRACK 1L T-Joint</b>
	A264-00-16-   B   N
	A264-00-17-   B   N

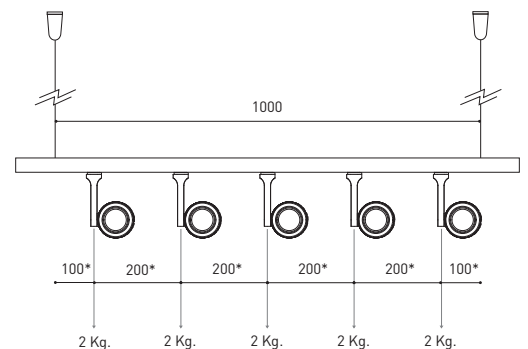

\*minimum distance (mm.)

COLOUR | B □ RAL 9016 | N ■ RAL 9005 | WT □ RAL 9016 | NT ■ RAL 9005 |

FLUSH MOUNTING

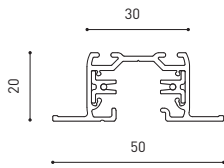
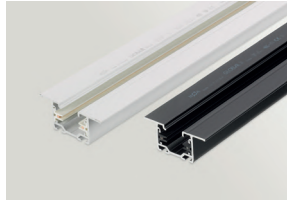

TRACK 1L FLUSH 1m	A264-11-00-   B   N
TRACK 1L FLUSH 2m	A264-12-00-   B   N
TRACK 1L FLUSH 3m	A264-13-00-   B   N



POLARITY GROOVE

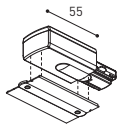

TRACK 1L FLUSH Live-End Connector

A264-00-01-   B   N
A264-00-02-   B   N

TRACK 1L FLUSH Cover Plate

A264-10-19-   B   N
---------------------

Mandatory for installation

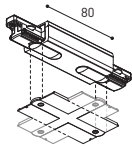

TRACK 1L FLUSH Central Connector

A264-00-03-   B   N
---------------------

TRACK 1L FLUSH Corner Cover Plate

A264-10-20-   B   N
---------------------

Mandatory for installation

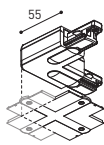

TRACK 1L FLUSH 90° Angle

A264-00-06-   B   N
A264-00-07-   B   N

TRACK 1L FLUSH Corner Cover Plate

A264-10-20-   B   N
---------------------

Mandatory for installation

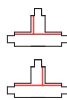
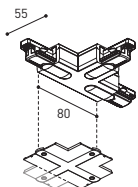

TRACK 1L FLUSH T-Joint

A264-00-16-   B   N
A264-00-17-   B   N

TRACK 1L FLUSH Corner Cover Plate

A264-10-20-   B   N
---------------------

Mandatory for installation

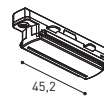

TRACK 1L Contact Joint

A264-00-04-   B   N
---------------------



TRACK 1L End

A264-00-13-   B   N
---------------------



TRACK 1L FLUSH Suspension Kit

A264-10-15
------------

For wire 1,5 mm [Not included]

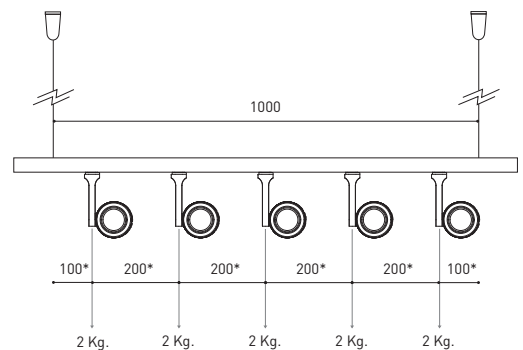

\*minimum distance [mm.]

COLOUR | B □ RAL 9016 | N ■ RAL 9005 |



Fuente de luz (LED) reemplazable por un profesional autorizado

Replaceable (LED only) light source by an authorized professional.

Source lumineuse (LED) remplaçable par un professionnel agréé

Sorgente luminosa (LED) sostituibile da parte di un professionista autorizzato

Austauschbare (LED) Lichtquelle durch einen autorisierten Fachmann



Equipo de control reemplazable por un profesional autorizado

Replaceable control gear by an authorized professional

Dispositif de commande remplaçable par un professionnel agréé

Alimentatore sostituibile da parte di un professionista autorizzato

Auswechselbares Betriebsgerät durch autorisierten Fachmann

INSTRUCCIONES PARA EL FINAL DE VIDA Y LA ELIMINACIÓN LOS COMPONENTES  
 INSTRUCTIONS ON END-OF-LIFE AND COMPONENT DISPOSAL  
 INSTRUCTIONS POUR LA GESTION DES COMPOSANTS EN FIN DE VIE ET LEUR MISE AU REBUT  
 ISTRUZIONI PER IL FINE VITA E LO SMALTIMENTO DEI COMPONENTI  
 ANWEISUNGEN ZUR ENTSORGUNG DER LEUCHTENKOMPONENTEN



Interrumpir la alimentación del aparato  
 Cut the power supply to the luminaire  
 Couper l'alimentation du luminaire  
 Interrompere l'alimentazione dell'apparecchio  
 Stromversorgung der Leuchte unterbrechen



Quitar la(s) fuente(s) de luz para el desecho  
 Remove light source(s) for disposal  
 Retirer la (les) source(s) lumineuse(s) pour l'élimination  
 Rimuovere la/le sorgente/e di luce per lo smaltimento  
 Lichtquelle(n) zur Entsorgung entfernen



Quitar la batería para el desecho  
 Remove the battery for decommissioning  
 Retirer la batterie pour sa mise au rebut  
 Rimuovere la batteria per la dismissione  
 Die Batterie ordnungsgemäß entsorgen



Quitar el equipo de control para el desecho  
 Remove control gear for disposal  
 Retirer le dispositif de commande pour l'élimination  
 Rimuovere l'alimentatore per lo smaltimento  
 Betriebsgerät zur Entsorgung ausbauen



Enviar los materiales a un centro de recogida RAEE  
 Send the materials to a WEEE collection centre  
 Envoyer les matériaux dans une déchetterie DEEE  
 Inviare i materiali ad un centro di raccolta RAEE  
 Die Materialien in einem WEEE-Zentrum entsorgen

