

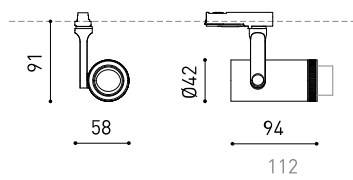

GRÖÖE



ZUBEHÖR



HIGH CHROMATIC LED



TRACK 1L OPTIONS

PREISE

PREMIO
ADCV 2019
ORO



PRODUKT

Name	PLUS MINI 1L 2700K NT
Artikelnummer	A3270020NT
Farbe	Schwarz strukturiert
RAL	9005
Kategorie	TRACKLIGHTS

LICHTQUELLE

Typ	LED
Bruttolichtstrom	480 lm
Farbtemperatur	2700 K
Farbstabilität	MacAdam Step 2
Farbwiedergabeindex	CRI > 90
Leistung	4,5 W
Stromstärke	500 mA
Lichtausbeute	107 lm/W
Nutzlebensdauer der LED in Betriebsstunden	L90B10 > 55.000h

LEUCHE | PHOTOMETRISCHE DATEN

Leuchtenwirkungsgrad (LOR)	20-40%
Abstrahlwinkel	10°-41°

LEUCHE | ELEKTRISCHE DATEN

Driver	Inklusiv
Leistungswerte des Systems	6,34 W
Spannung	220V/240V
Frequenz	50/60 Hz
Helligkeitssteuerung	No Dim
Schutzklasse	⊕

ANDERE DATEN

Dichtigkeit	IP20
Schwenkwinkel	180°
Drehwinkel	350°
Schiennentyp	Track 1L
Gewicht	237 g
Gewicht inkl. Verpackung	320 g
Abmessungen der Verpackung	199 x 162 x 63 mm
Stück pro Verpackung	1
Materialien	Aluminium / Optical Polymethylmetacrylat



Plus Mini 1L ist ein miniaturisierter Strahler, der für eine einphasige Schiene gedacht ist und die Möglichkeit bietet, die Öffnung des Lichtstrahls mit einer leichten manuellen Bewegung zu erweitern oder zu konzentrieren. Diese Funktion macht Plus zum idealen Projektor für Anwendungen, bei denen die Präzision des Lichtstrahls ein wesentliches Element ist, wie z. B. Museen, Ausstellungen, Einzelhandel oder Akzentanwendungen.

POLAR-KOORDINATEN DIAGRAMM



cd/klm
 — C0 - C180 — C90 - C270

KEGELDIAGRAMM

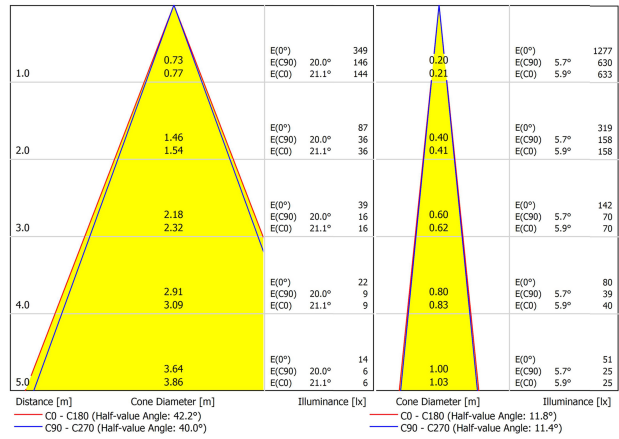

FÜR DIE PRODUKTPRÄSENTATION

Vivid Model Colour Temperature	2700K	3000K	3500K	4000K	Light Pink
📖 Reading			•	•	
🥬 Fruits & Vegetables		•	•		
🍞 Bakery	•				
👤 Retail		•	•		
💄 Cosmetics			•	•	
🥩 Meat					•
🐟 Fish				•	
🐠 Seafood				•	•



Einige der Produkte von Arkoslight können mit einer Spezial-LED für die visuelle Bewerbung von Waren und Produkten zur Verkaufsförderung ausgerüstet werden.

Dabei handelt es sich um eine hochchromatische LED, um Farbtöne hervorzuheben, die positive psychologische Wahrnehmung des beleuchteten Objekts begünstigen.

Diese spezielle LED-Lichtquelle bietet eine ansprechendere und intensivere Farbpalette als eine herkömmliche LED. Dies wird durch die Konfiguration der LED nach einem "speziellen Sättigungsparameter" erreicht, der Farben und Textur der Objekte innerhalb des sichtbaren Spektralbereichs attraktiver erscheinen lässt. Dafür wird die jeweils zweckdienliche Diode und spezifische Phosphorbeschichtung gewählt.

SURFACE & SUSPENDED

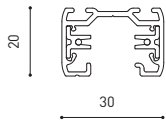

TRACK 1L 1m	A264-01-00- B N
TRACK 1L 2m	A264-02-00- B N
TRACK 1L 3m	A264-03-00- B N



POLARITY GROOVE

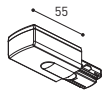

	TRACK 1L Live-End Connector
	A264-00-01- B N
	A264-00-02- B N

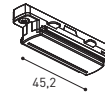

	TRACK 1L Contact Joint
	A264-00-04- B N

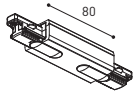

	TRACK 1L Central Connector
	A264-00-03- B N



	TRACK 1L End
	A264-00-13- B N

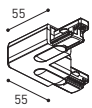

	TRACK 1L 90° Angle
	A264-00-06- B N
	A264-00-07- B N

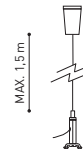

	TRACK 1L Suspension Kit
	A264-00-14- WT NT
<small>At least 2 units needed</small>	

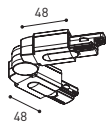

	TRACK 1L Corner connector
	A264-00-15- B N

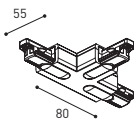

	TRACK 1L T-Joint
	A264-00-16- B N
	A264-00-17- B N

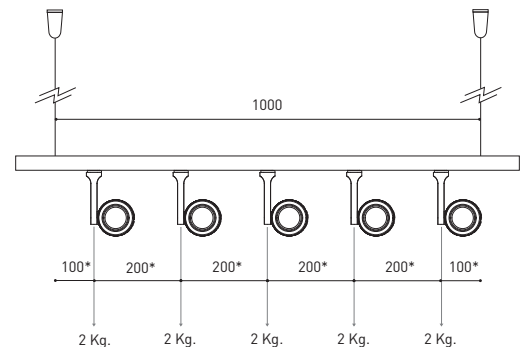

*minimum distance (mm.)

COLOUR | B □ RAL 9016 | N ■ RAL 9005 | WT □ RAL 9016 | NT ■ RAL 9005 |

FLUSH MOUNTING

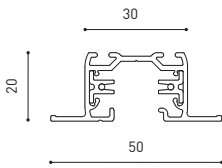
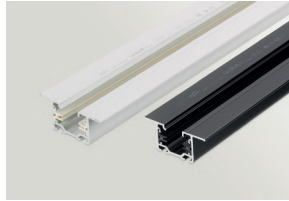

TRACK 1L FLUSH 1m	A264-11-00- B N
TRACK 1L FLUSH 2m	A264-12-00- B N
TRACK 1L FLUSH 3m	A264-13-00- B N



POLARITY GROOVE

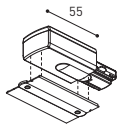

TRACK 1L FLUSH Live-End Connector

A264-00-01- B N
A264-00-02- B N

TRACK 1L FLUSH Cover Plate

A264-10-19- B N

Mandatory for installation

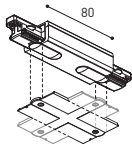

TRACK 1L FLUSH Central Connector

A264-00-03- B N

TRACK 1L FLUSH Corner Cover Plate

A264-10-20- B N

Mandatory for installation

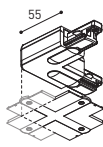

TRACK 1L FLUSH 90° Angle

A264-00-06- B N
A264-00-07- B N

TRACK 1L FLUSH Corner Cover Plate

A264-10-20- B N

Mandatory for installation

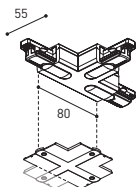

TRACK 1L FLUSH T-Joint

A264-00-16- B N
A264-00-17- B N

TRACK 1L FLUSH Corner Cover Plate

A264-10-20- B N

Mandatory for installation

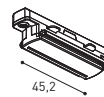

TRACK 1L Contact Joint

A264-00-04- B N



TRACK 1L End

A264-00-13- B N



TRACK 1L FLUSH Suspension Kit

A264-10-15

For wire 1,5 mm [Not included]

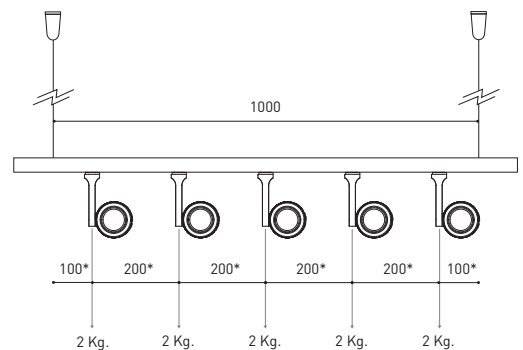

*minimum distance [mm.]

COLOUR | B □ RAL 9016 | N ■ RAL 9005 |



Fuente de luz (LED) reemplazable por un profesional autorizado
 Replaceable (LED only) light source by an authorized professional.
 Source lumineuse (LED) remplaçable par un professionnel agréé
 Sorgente luminosa (LED) sostituibile da parte di un professionista autorizzato
 Austauschbare (LED) Lichtquelle durch einen autorisierten Fachmann



Equipo de control reemplazable por un profesional autorizado
 Replaceable control gear by an authorized professional
 Dispositif de commande remplaçable par un professionnel agréé
 Alimentatore sostituibile da parte di un professionista autorizzato
 Auswechselbares Betriebsgerät durch autorisierten Fachmann

INSTRUCCIONES PARA EL FINAL DE VIDA Y LA ELIMINACIÓN LOS COMPONENTES
 INSTRUCTIONS ON END-OF-LIFE AND COMPONENT DISPOSAL
 INSTRUCTIONS POUR LA GESTION DES COMPOSANTS EN FIN DE VIE ET LEUR MISE AU REBUT
 ISTRUZIONI PER IL FINE VITA E LO SMALTIMENTO DEI COMPONENTI
 ANWEISUNGEN ZUR ENTSORGUNG DER LEUCHTENKOMPONENTEN



Interrumpir la alimentación del aparato
 Cut the power supply to the luminaire
 Couper l'alimentation du luminaire
 Interrompere l'alimentazione dell'apparecchio
 Stromversorgung der Leuchte unterbrechen



Quitar la(s) fuente(s) de luz para el desecho
 Remove light source(s) for disposal
 Retirer la (les) source(s) lumineuse(s) pour l'élimination
 Rimuovere la/le sorgente/e di luce per lo smaltimento
 Lichtquelle(n) zur Entsorgung entfernen



Quitar la batería para el desecho
 Remove the battery for decommissioning
 Retirer la batterie pour sa mise au rebut
 Rimuovere la batteria per la dismissione
 Die Batterie ordnungsgemäß entsorgen



Quitar el equipo de control para el desecho
 Remove control gear for disposal
 Retirer le dispositif de commande pour l'élimination
 Rimuovere l'alimentatore per lo smaltimento
 Betriebsgerät zur Entsorgung ausbauen

Enviar los materiales a un centro de recogida RAEE
 Send the materials to a WEEE collection centre
 Envoyer les matériaux dans une déchetterie DEEE
 Inviare i materiali ad un centro di raccolta RAEE
 Die Materialien in einem WEEE-Zentrum entsorgen

