

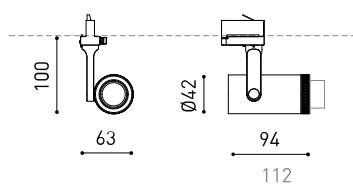

## DIMENSIONES



## ACCESORIOS



HIGH CHROMATIC LED



TRACK 3L OPTIONS

## PREMIOS



Nombre	PLUS MINI 3L 2700K WT
Referencia	A3270010WT
Color	Blanco Texturado
RAL	9016
Categoría	TRACKLIGHTS

## FUENTE DE LUZ

Tipo	LED
Flujo Luminoso	480 lm
Temperatura de color	2700 K
Estabilidad cromática	MacAdam Step 2
Índice de reproducción cromática	CRI > 90
Potencia	4,5 W
Corriente	500 mA
Eficacia	107 lm/W
Horas de Vida del LED	L90B10 > 55.000h

## LUMINARIA | DATOS FOTOMÉTRICOS

Eficiencia Lumínica	20-40%
Ángulo del haz de luz	10°-41°

## LUMINARIA | DATOS ELÉCTRICOS

Driver	Incluido
Potencia del sistema	6,34 W
Tensión	220V/240V
Frecuencia	50/60 Hz
Regulación	No Dim
Clase de seguridad eléctrica	⚡

## OTROS DATOS

Estanqueidad	IP20
Control inalámbrico	Consultar
Ángulo de basculación	180°
Ángulo de giro	350°
Tipo de carril	Track 3L+N
Peso	257 g
Peso con embalaje	340 g
Dimensiones embalaje	199 x 162 x 63 mm
Unidades por embalaje	1
Materiales	Aluminio / Polimetilmetacrilato Óptico



Plus es un proyector que ofrece la capacidad de ampliar o concentrar la apertura del haz de luz con un suave movimiento manual. Su sistema óptico lo forman un objetivo provisto de una lente colimadora y una pantalla retráctil tipo "snoot". Con la acción manual del usuario, lente y "snoot" actúan como un zoom (se alejan o acercan al LED) y gradúan el ángulo del haz de luz de "flood" a "spot" o viceversa. Esta característica hace a Plus el proyector ideal para aplicaciones donde la precisión del haz de luz es un elemento esencial, tales como museos, exposiciones, retail o aplicaciones de acento.

DIAGRAMA POLAR

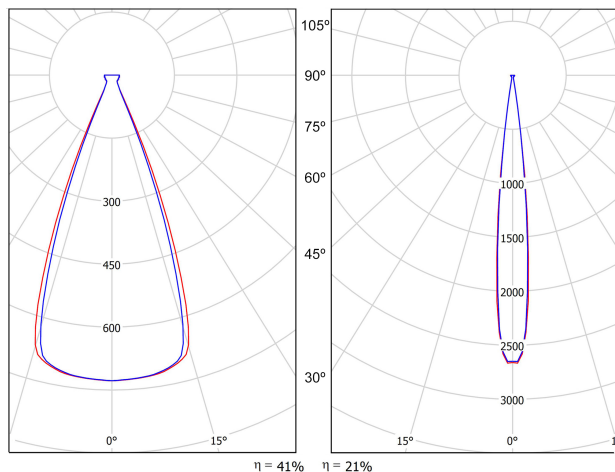

cd/klm  
 — C0 - C180 — C90 - C270

DIAGRAMA CÓNICO

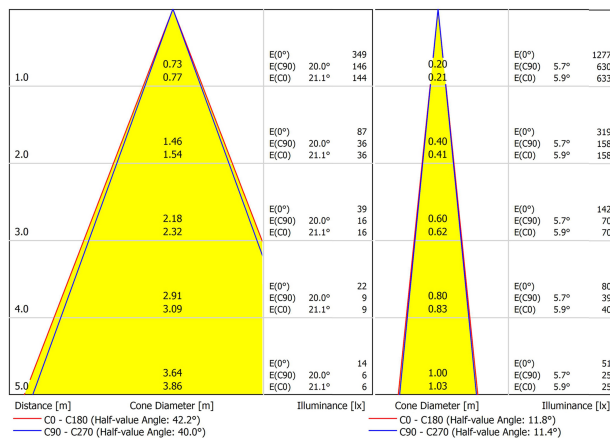

PARA PRESENTACIÓN COMERCIAL DE PRODUCTO

Vivid Model Colour Temperature	2700K	3000K	3500K	4000K	Light Pink
📖 Reading			•	•	
🥬 Fruits & Vegetables		•	•		
🍞 Bakery	•				
👤 Retail		•	•		
💄 Cosmetics			•	•	
🥩 Meat					•
🐟 Fish				•	
🐠 Seafood				•	•



Arkosligh ofrece en algunos de sus productos la posibilidad de dotarlos de un LED especial para iluminación orientada a la promoción visual de bienes y productos con finalidad comercial.

Se trata de un LED de alta cromaticidad que persigue destacar los tonos que favorecen la percepción psicológica positiva del objeto iluminado.

Esta fuente de luz LED especial ofrece una paleta de colores más atractiva e intensa, por encima de lo que lo hace un LED convencional. Esto se consigue gracias a la configuración del LED bajo un "parámetro especial de saturación" que consigue que los colores y la textura de los objetos se muestren más atractivos dentro del espectro de luz visible. Para ello se selecciona, en cada caso, el diodo pertinente y su fósforo de recubrimiento específico.

## TRACK 3L+N SURFACE & SUSPENDED

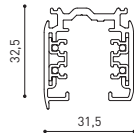

TRACK 3L 1m	A282-01-00-   B   N
TRACK 3L 2m	A282-02-00-   B   N
TRACK 3L 3m	A282-03-00-   B   N



## TRACK 3L+N FLUSH MOUNTING\*

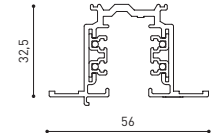

TRACK 3L FLUSH 1m	A282-11-00-   B   N
TRACK 3L FLUSH 2m	A282-12-00-   B   N
TRACK 3L FLUSH 3m	A282-13-00-   B   N



## WEIGHT BEAR CAPACITY

Distancia de fijación y capacidad de carga.  
Distancia fijación recomendada l- 1000 mm.

Fastening distance and loading capacity.  
Recommended fastening distance l- 1000 mm.

Distance de fixation et capacité de charge.  
Distance de fixation recommandée l- 1000 mm.

Distanza di installazione e capacità di carico.  
Distanza consigliata di fissazione l- 1000 mm.

Befestigungsabstand und Belastbarkeit.  
Empfohlener Abstand l- 1000 mm.

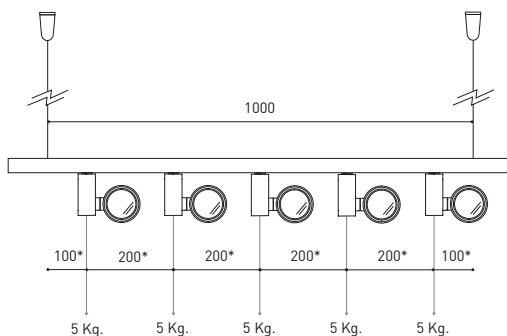

\*minimum distance (mm.)

## ACCESSORIES

FIT MODEL: ACCESSORIES ONLY IN BLACK FINISH  
SIX MODEL: ACCESSORIES NOT AVAILABLE

### TRACKLIGHT Surface Adapter

0000-55-43- | W |

0000-55-39- | N |



### TRACKLIGHT Recessed Adapter

0000-55-44- | W |

0000-55-40- | N |



COLOUR | B □ RAL 9016 | N ■ RAL 9005 |

Calle N · Pol. Ind. EL OLIVERAL  
46394 Ribarroja del Turia · Valencia (Spain)  
Tel. +34 961 667 207 · Fax +34 961 667 054  
info@arkoslight.com · www.arkoslight.com



## SURFACE & SUSPENDED

## FLUSH MOUNTING

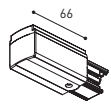

POLARITY GROOVE



### TRACK 3L Live-End Connector

A282-00-01- | B | N |

A282-00-02- | B | N |

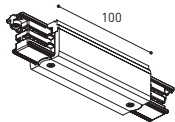

### TRACK 3L Central Connector

A282-00-03- | B | N |



### TRACK 3L Ceiling Kit

A219-21-06- | B | N |

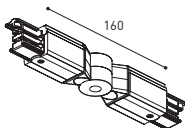

### TRACK 3L Universal Angle

A282-00-15- | B | N |

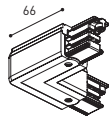

### TRACK 3L 90° Angle

A282-00-06- | B | N |

A282-00-07- | B | N |

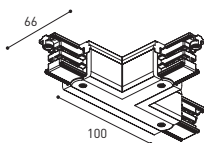

### TRACK 3L T Joint

A282-00-16- | B | N |

A282-00-17- | B | N |

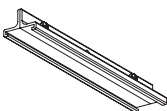

### TRACK 3L Mechanical Joint

A219-21-11- | B | N |



### TRACK 3L Suspension Kit

A219-21-10- | B | N |

At least 2 units needed

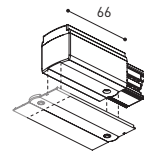

POLARITY GROOVE



### TRACK 3L Live-End Connector

A282-00-01- | B | N |

A282-00-02- | B | N |

### TRACK 3L FLUSH Cover Plate

A282-10-19- | B | N |

Mandatory for installation

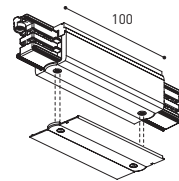

### TRACK 3L Central Connector

A282-00-03- | B | N |

### TRACK 3L FLUSH Cover Plate

A282-10-19- | B | N |

Mandatory for installation



### TRACK 3L FLUSH Ceiling Kit

A219-22-06- | B |

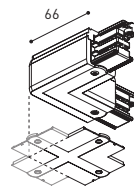

### TRACK 3L 90° Angle

A282-00-06- | B | N |

A282-00-07- | B | N |



### TRACK 3L FLUSH Corner Cover Plate

A282-10-20- | B | N |

Mandatory for installation

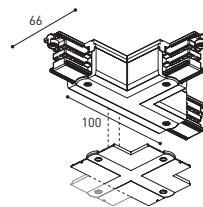

### TRACK 3L T Joint

A282-00-16- | B | N |

A282-00-17- | B | N |



### TRACK 3L FLUSH Corner Cover Plate

A282-10-20- | B | N |

Mandatory for installation

## SURFACE & SUSP. / FLUSH MOUNTING

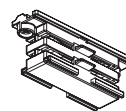

### TRACK Contact Joint

A282-00-04- | B | N |



### TRACK End

A219-20-02- | B | N |



### TRACK Clamp Kit for M6 ROD

A219-21-21- | B |

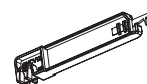

### TRACK Bending Tool

A282-00-00

For tracks its length has been modified

COLOUR | B □ RAL 9016 | N ■ RAL 9005 |



Fuente de luz (LED) reemplazable por un profesional autorizado  
 Replaceable (LED only) light source by an authorized professional.  
 Source lumineuse (LED) remplaçable par un professionnel agréé  
 Sorgente luminosa (LED) sostituibile da parte di un professionista autorizzato  
 Austauschbare (LED) Lichtquelle durch einen autorisierten Fachmann



Equipo de control reemplazable por un profesional autorizado  
 Replaceable control gear by an authorized professional  
 Dispositif de commande remplaçable par un professionnel agréé  
 Alimentatore sostituibile da parte di un professionista autorizzato  
 Auswechselbares Betriebsgerät durch autorisierten Fachmann

INSTRUCCIONES PARA EL FINAL DE VIDA Y LA ELIMINACIÓN LOS COMPONENTES  
 INSTRUCTIONS ON END-OF-LIFE AND COMPONENT DISPOSAL  
 INSTRUCTIONS POUR LA GESTION DES COMPOSANTS EN FIN DE VIE ET LEUR MISE AU REBUT  
 ISTRUZIONI PER IL FINE VITA E LO SMALTIMENTO DEI COMPONENTI  
 ANWEISUNGEN ZUR ENTSORGUNG DER LEUCHTENKOMPONENTEN



Interrumpir la alimentación del aparato  
 Cut the power supply to the luminaire  
 Couper l'alimentation du luminaire  
 Interrompere l'alimentazione dell'apparecchio  
 Stromversorgung der Leuchte unterbrechen



Quitar la(s) fuente(s) de luz para el desecho  
 Remove light source(s) for disposal  
 Retirer la (les) source(s) lumineuse(s) pour l'élimination  
 Rimuovere la/le sorgente/e di luce per lo smaltimento  
 Lichtquelle(n) zur Entsorgung entfernen



Quitar la batería para el desecho  
 Remove the battery for decommissioning  
 Retirer la batterie pour sa mise au rebut  
 Rimuovere la batteria per la dismissione  
 Die Batterie ordnungsgemäß entsorgen



Quitar el equipo de control para el desecho  
 Remove control gear for disposal  
 Retirer le dispositif de commande pour l'élimination  
 Rimuovere l'alimentatore per lo smaltimento  
 Betriebsgerät zur Entsorgung ausbauen

Enviar los materiales a un centro de recogida RAEE  
 Send the materials to a WEEE collection centre  
 Envoyer les matériaux dans une déchetterie DEEE  
 Inviare i materiali ad un centro di raccolta RAEE  
 Die Materialien in einem WEEE-Zentrum entsorgen

