

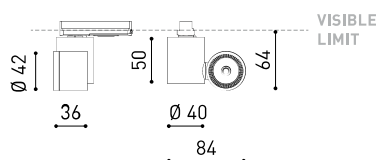

DIMENSIONS



ACCESSORIES



HIGH CHROMATIC LED



BEAM MIXER DIFFUSER

ANTI-GLARE HONEYCOMB
LOUVER

TRACK 1L OPTIONS

AWARDS

Silver Delta
ADI Awards
2016DESIGN
AWARD
2017PREMIO
ADCV 2017
OROGOOD
DESIGN

PRODUCT

Name	IO 20° 4000K WT
Reference	A2620012WT
Color	Textured white
RAL	9016
Category	TRACKLIGHTS

LIGHT SOURCE

Type	LED
Gross luminous flux	520 lm
Colour temperature	4000 K
Chromatic stability	MacAdam Step 2
Colour Rendering Index	CRI > 90
Power	4,5 W
Current	500 mA
Efficacy	116 lm/W
LED lifespan	L90B10 > 55.000h

LIGHTING FIXTURE | PHOTOMETRIC DATA

Lighting efficiency	92%
Light beam angle	20°

LIGHTING FIXTURE | ELECTRICAL DATA

Driver	Included
Power values of the system	6,34 W
Voltage	220V/240V
Frecuency	50/60 Hz
Dimming	No Dim
Electrical insulation class	⊕

OTHER DATA

Sealing	IP20
Swivel angle	325°
Rotation angle	355°
Track type	Track 1L
Weight	160 g
Packaged weight	205,2 g
Packaging dimensions	116 x 105,5 x 56 mm
Units per package	1
Materials	Aluminium / Polycarbonate



"iO" is a LED spotlight miniaturised in a fixture that is so small that it fits on the palm of your hand. Designed for accent lighting applications, its small dimensions mean it can be fitted in display cabinets, shop windows and small places without generating an invasive presence on the scene. Created to be placed on a track, it offers all the features of concentrated LED spotlights with a minimalist and hyper-reduced design.

POLAR DIAGRAM



CONICAL DIAGRAM

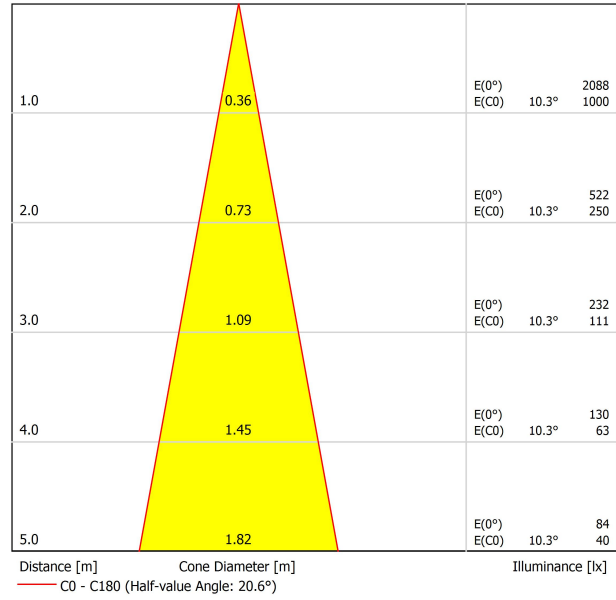

Vivid Model Colour Temperature	2700K	3000K	3500K	4000K	Light Pink
📖 Reading			•	•	
🥬 Fruits & Vegetables		•	•		
🍞 Bakery	•				
👤 Retail		•	•		
💄 Cosmetics			•	•	
🥩 Meat					•
🐟 Fish				•	
🐠 Seafood				•	•



For some of its products, Arkoslight offers the possibility to provide them with a special LED, designed to create an illumination focused on visually promoting goods or products for commercial purposes. It is a high chromaticity LED, capable of identifying the colour shades that produce a positive psychological perception of the illuminated object.

This special LED lighting source offers a much more attractive and intense colour range than a conventional LED, besides being much wider. Technically, this is possible thanks to a special LED setting that includes a «special saturation parameter», capable of highlighting the objects colours and materials in such a way that they seem more attractive within the visible light spectrum. To achieve this performance, in each case, the appropriate diode and specific phosphor coating are carefully selected.



	PRODUCT
Model	Beam Mixer Diffuser
Reference	08050100
Category	Accessories

NOT SOLD SEPARATELY.

The Beam Mixer Diffuser is used to smooth beam artifacts caused by parabolic, Fresnel, or TIR lens collimators without significant broadening.

The unique mixing design provides superior far-field smoothing and color mixing with high on-axis brightness. Compared with traditional diffusers, it maintains higher central beam candlepower (CBCP), and produce less undesirable "field light" at higher angles.



	PRODUCT
Model	Anti-glare Honeycomb Louver
Reference	08060000WT
Colour	WT □ Textured white
Category	Accessories

NOT SOLD SEPARATELY.



Accessory made up of louver in the shape of a honeycomb panel to reduce glare and the effects of direct rays of vision.

SURFACE & SUSPENDED

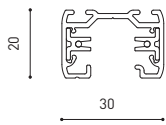

TRACK 1L 1m	A264-01-00- B N
TRACK 1L 2m	A264-02-00- B N
TRACK 1L 3m	A264-03-00- B N



POLARITY GROOVE

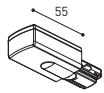

	TRACK 1L Live-End Connector
	A264-00-01- B N
	A264-00-02- B N

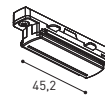

	TRACK 1L Contact Joint
	A264-00-04- B N

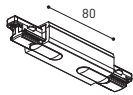

	TRACK 1L Central Connector
	A264-00-03- B N



	TRACK 1L End
	A264-00-13- B N

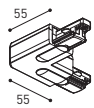

	TRACK 1L 90° Angle
	A264-00-06- B N
	A264-00-07- B N

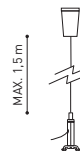

	TRACK 1L Suspension Kit
	A264-00-14- WT NT
<small>At least 2 units needed</small>	

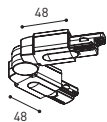

	TRACK 1L Corner connector
	A264-00-15- B N

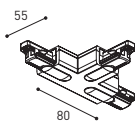

	TRACK 1L T-Joint
	A264-00-16- B N
	A264-00-17- B N

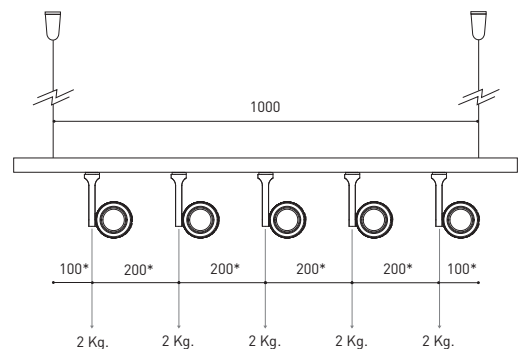

*minimum distance (mm.)

COLOUR | B □ RAL 9016 | N ■ RAL 9005 | WT □ RAL 9016 | NT ■ RAL 9005 |

FLUSH MOUNTING

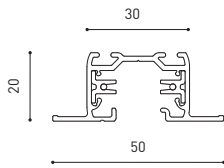
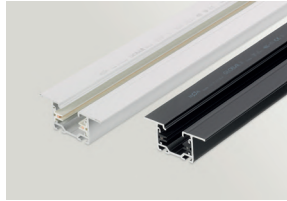

TRACK 1L FLUSH 1m	A264-11-00- B N
TRACK 1L FLUSH 2m	A264-12-00- B N
TRACK 1L FLUSH 3m	A264-13-00- B N



POLARITY GROOVE

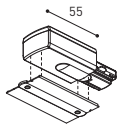

TRACK 1L FLUSH Live-End Connector

A264-00-01- B N
A264-00-02- B N

TRACK 1L FLUSH Cover Plate

A264-10-19- B N

Mandatory for installation

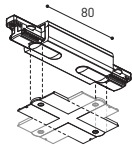

TRACK 1L FLUSH Central Connector

A264-00-03- B N

TRACK 1L FLUSH Corner Cover Plate

A264-10-20- B N

Mandatory for installation

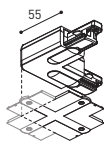

TRACK 1L FLUSH 90° Angle

A264-00-06- B N
A264-00-07- B N

TRACK 1L FLUSH Corner Cover Plate

A264-10-20- B N

Mandatory for installation

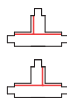
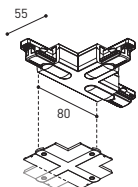

TRACK 1L FLUSH T-Joint

A264-00-16- B N
A264-00-17- B N

TRACK 1L FLUSH Corner Cover Plate

A264-10-20- B N

Mandatory for installation

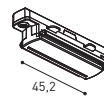

TRACK 1L Contact Joint

A264-00-04- B N



TRACK 1L End

A264-00-13- B N



TRACK 1L FLUSH Suspension Kit

A264-10-15

For wire 1,5 mm [Not included]

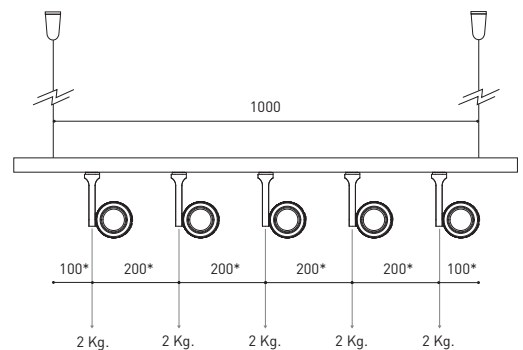

*minimum distance [mm.]

COLOUR | B □ RAL 9016 | N ■ RAL 9005 |



Fuente de luz (LED) reemplazable por un profesional autorizado

Replaceable (LED only) light source by an authorized professional.

Source lumineuse (LED) remplaçable par un professionnel agréé

Sorgente luminosa (LED) sostituibile da parte di un professionista autorizzato

Austauschbare (LED) Lichtquelle durch einen autorisierten Fachmann



Equipo de control reemplazable por un profesional autorizado

Replaceable control gear by an authorized professional

Dispositif de commande remplaçable par un professionnel agréé

Alimentatore sostituibile da parte di un professionista autorizzato

Auswechselbares Betriebsgerät durch autorisierten Fachmann

INSTRUCCIONES PARA EL FINAL DE VIDA Y LA ELIMINACIÓN LOS COMPONENTES
 INSTRUCTIONS ON END-OF-LIFE AND COMPONENT DISPOSAL
 INSTRUCTIONS POUR LA GESTION DES COMPOSANTS EN FIN DE VIE ET LEUR MISE AU REBUT
 ISTRUZIONI PER IL FINE VITA E LO SMALTIMENTO DEI COMPONENTI
 ANWEISUNGEN ZUR ENTSORGUNG DER LEUCHTENKOMPONENTEN



Interrumpir la alimentación del aparato
 Cut the power supply to the luminaire
 Couper l'alimentation du luminaire
 Interrompere l'alimentazione dell'apparecchio
 Stromversorgung der Leuchte unterbrechen



Quitar la(s) fuente(s) de luz para el desecho
 Remove light source(s) for disposal
 Retirer la (les) source(s) lumineuse(s) pour l'élimination
 Rimuovere la/le sorgente/e di luce per lo smaltimento
 Lichtquelle(n) zur Entsorgung entfernen



Quitar la batería para el desecho
 Remove the battery for decommissioning
 Retirer la batterie pour sa mise au rebut
 Rimuovere la batteria per la dismissione
 Die Batterie ordnungsgemäß entsorgen



Quitar el equipo de control para el desecho
 Remove control gear for disposal
 Retirer le dispositif de commande pour l'élimination
 Rimuovere l'alimentatore per lo smaltimento
 Betriebsgerät zur Entsorgung ausbauen



Enviar los materiales a un centro de recogida RAEE
 Send the materials to a WEEE collection centre
 Envoyer les matériaux dans une déchetterie DEEE
 Inviare i materiali ad un centro di raccolta RAEE
 Die Materialien in einem WEEE-Zentrum entsorgen

