

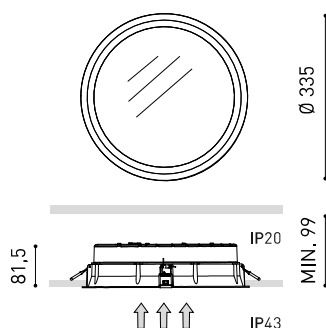

DIMENSIONI



Nome	DEEP MAXI 5 DIM DALI 4000K WT
Articolo	A2480542WT
Colore	Bianco Strutturato
RAL	9016
Categoria	CEILING RECESSED

Tipo	LED
Flusso luminoso lordo	5925 lm
Temperatura di colore	4000 K
Stabilità cromatica	MacAdam Step 2
Indice di Riproduzione Cromatica	CRI > 90
Potenza	40 W
Corrente	900 mA
Efficienza	148 lm/W
Ore di vita del LED	L80B10 > 60.000h

SORGENTE DI LUCE

Efficienza luminosa	85%
Angolo del fascio di luce	99°

APPARECCHIO | DATI FOTOMETRICI

Driver	Incluso - Collegato
Valori di potenza del sistema	43,48 W
Tensione	220V/240V
Frequenza	50/60 Hz
Regolazione	DALI
Classe di isolamento elettrico	<input type="checkbox"/>

APPARECCHIO | DATI ELETTRICI

Tenuta stagna	IP43
Wireless control	Consultare
Alimentazione di emergenza	Consultare
Resistenza agli urti	IK07
Misure di incasso	Ø320 mm
Peso	2010 g
Peso compresso l'imballaggio	2455,9 g
Dimensioni dell'imballaggio	420 x 370 x 105 mm
Unità per imballaggio	1
Materiali	Alluminio / Polimetilmetacrilato

ALTRI DATI



Deep è un downlight LED per funzioni di illuminazione generale che spicca per il suo aspetto attraente, dove il diffusore è spiccatamente arretrato rispetto al piano della cornice perimetrale.

DIAGRAMMA DI ABBAGLIAMENTO POLARE



DIAGRAMMA CONICO

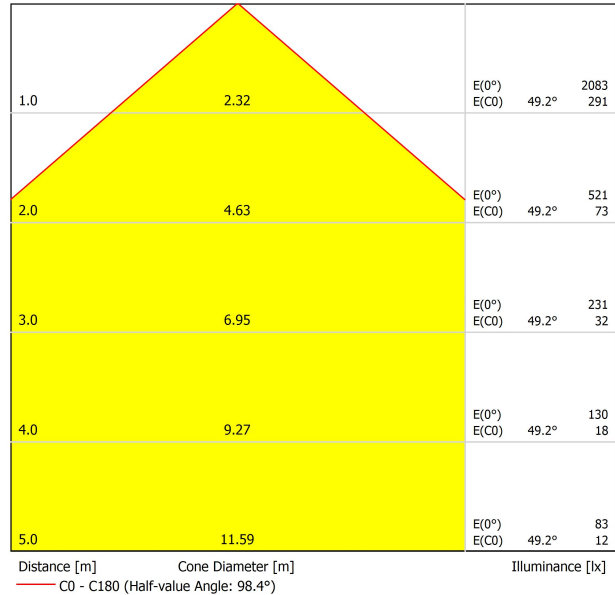

UGR

Glare Evaluation According to UGR											
ρ Ceiling	70	70	50	50	30	70	70	50	50	30	
ρ Walls	50	30	50	30	30	50	30	50	30	30	
ρ Floor	20	20	20	20	20	20	20	20	20	20	
Room Size X Y		Viewing direction at right angles to lamp axis					Viewing direction parallel to lamp axis				
2H	2H	23.0	24.2	23.3	24.5	24.7	23.0	24.2	23.3	24.5	24.7
	3H	24.4	25.5	24.7	25.8	26.1	24.4	25.5	24.7	25.8	26.1
	4H	24.9	25.9	25.2	26.2	26.5	24.9	25.9	25.2	26.2	26.5
	6H	25.1	26.1	25.5	26.4	26.7	25.1	26.1	25.5	26.4	26.7
	8H	25.2	26.1	25.5	26.4	26.7	25.2	26.1	25.5	26.4	26.7
4H	2H	23.5	24.5	23.8	24.8	25.1	23.5	24.5	23.8	24.8	25.1
	3H	25.1	26.0	25.5	26.3	26.6	25.1	26.0	25.5	26.3	26.6
	4H	25.6	26.4	26.0	26.8	27.2	25.6	26.4	26.0	26.8	27.2
	6H	26.0	26.7	26.4	27.1	27.5	26.0	26.7	26.4	27.1	27.5
	8H	26.1	26.7	26.5	27.1	27.5	26.1	26.7	26.5	27.1	27.5
8H	2H	26.2	26.7	26.6	27.2	27.6	26.2	26.7	26.6	27.2	27.6
	4H	25.8	26.5	26.3	26.9	27.3	25.8	26.5	26.3	26.9	27.3
	6H	26.3	26.8	26.7	27.2	27.7	26.3	26.8	26.7	27.2	27.7
	8H	26.4	26.9	26.9	27.3	27.8	26.4	26.9	26.9	27.3	27.8
	12H	26.6	27.0	27.1	27.4	27.9	26.6	27.0	27.1	27.4	27.9
12H	4H	25.8	26.4	26.3	26.8	27.3	25.8	26.4	26.3	26.8	27.3
	6H	26.3	26.7	26.8	27.2	27.7	26.3	26.7	26.8	27.2	27.7
	8H	26.5	26.9	27.0	27.3	27.8	26.5	26.9	27.0	27.3	27.8
Variation of the observer position for the luminaire distances S											
S = 1.0H	+0.2 / -0.2					+0.2 / -0.2					
S = 1.5H	+0.3 / -0.6					+0.3 / -0.6					
S = 2.0H	+0.6 / -1.0					+0.6 / -1.0					
Standard table	BK04					BK04					
Correction Summand	2.2					2.2					
Corrected Glare Indices referring to 5925lm Total Luminous Flux											



Fuente de luz (LED) reemplazable por un profesional autorizado

Replaceable (LED only) light source by an authorized professional.

Source lumineuse (LED) remplaçable par un professionnel agréé

Sorgente luminosa (LED) sostituibile da parte di un professionista autorizzato

Austauschbare (LED) Lichtquelle durch einen autorisierten Fachmann



Equipo de control reemplazable por un profesional autorizado

Replaceable control gear by an authorized professional

Dispositif de commande remplaçable par un professionnel agréé

Alimentatore sostituibile da parte di un professionista autorizzato

Auswechselbares Betriebsgerät durch autorisierten Fachmann

INSTRUCCIONES PARA EL FINAL DE VIDA Y LA ELIMINACIÓN LOS COMPONENTES
 INSTRUCTIONS ON END-OF-LIFE AND COMPONENT DISPOSAL
 INSTRUCTIONS POUR LA GESTION DES COMPOSANTS EN FIN DE VIE ET LEUR MISE AU REBUT
 ISTRUZIONI PER IL FINE VITA E LO SMALTIMENTO DEI COMPONENTI
 ANWEISUNGEN ZUR ENTSORGUNG DER LEUCHTENKOMPONENTEN



Interrumpir la alimentación del aparato
 Cut the power supply to the luminaire
 Couper l'alimentation du luminaire
 Interrompere l'alimentazione dell'apparecchio
 Stromversorgung der Leuchte unterbrechen



Quitar la(s) fuente(s) de luz para el desecho
 Remove light source(s) for disposal
 Retirer la (les) source(s) lumineuse(s) pour l'élimination
 Rimuovere la/le sorgente/e di luce per lo smaltimento
 Lichtquelle(n) zur Entsorgung entfernen



Quitar la batería para el desecho
 Remove the battery for decommissioning
 Retirer la batterie pour sa mise au rebut
 Rimuovere la batteria per la dismissione
 Die Batterie ordnungsgemäß entsorgen



Quitar el equipo de control para el desecho
 Remove control gear for disposal
 Retirer le dispositif de commande pour l'élimination
 Rimuovere l'alimentatore per lo smaltimento
 Betriebsgerät zur Entsorgung ausbauen



Enviar los materiales a un centro de recogida RAEE
 Send the materials to a WEEE collection centre
 Envoyer les matériaux dans une déchetterie DEEE
 Inviare i materiali ad un centro di raccolta RAEE
 Die Materialien in einem WEEE-Zentrum entsorgen

